

Master Flux

Plus

LABEL:



<i>Istruzioni per l'uso</i>	ITALIANO	
<i>Instructions for use</i>	ENGLISH	<i>Translation</i>
<i>Mode d'emploi</i>	FRANCAIS	<i>Traduction</i>
<i>Bedienungsanleitung</i>	DEUTSCH	<i>Übersetzung</i>
<i>Instrucciones de uso</i>	ESPAÑOL	<i>Traducción</i>
<i>Instruções de uso</i>	PORTUGUÊS	<i>Tradução</i>

Questo manuale è idoneo per i seguenti articoli:

This manual is suitable for the following items:

Ce manuel est adapté pour les éléments suivants:

Dieses Handbuch ist geeignet für die folgenden Elemente:

Este manual es adecuado para los siguientes elementos:

Este manual é adequado para os seguintes itens:

Ref:
1600AS
1600ASF
1600ASD
MF006ZMF
MF007ZMF
MF009ZMF
1601AS
1601ASD
1601ASF
MF008ZMF
MF010ZMF

Questo apparecchio assolve ai criteri di conformità CE in quanto conforme alla direttiva 93/42/CEE. La dichiarazione di conformità originale è fornita in allegato al manuale.

This device compliance to Directive 93/42/CE. The original declaration of conformity is provided in attached to the manual.

Cet appareil est conforme aux prescriptions CE puisque il respecte la instruction 93/42/CEE. La déclaration de conformité est jointe au manuel d'usage.

Das Gerät stimmt mit CE Norm. Es beachtet die Norm 93/42/EWG. Die Original Konformitätserklärung ist der Gebrauchsanleitung beigefügt.

El dispositivo es conforme con los criterios CE ya que respecta la norma 93/42/CE. La declaración original es incluida en el manual de uso.



INDICE

- 1. IMPIEGO E DESTINAZIONE D'USO DEL DISPOSITIVO**
- 2. SICUREZZA**
 - 2.1 MARCATURA DI SICUREZZA
 - 2.2 DISPOSITIVI DI SICUREZZA
 - 2.3 MOVIMENTAZIONE
 - 2.4 SMALTIMENTO
- 3. DATI TECNICI**
- 4. DISINBALLAGGIO**
- 5. COMPONENTI**
 - 5.1 ELENCO COMPONENTI IN DOTAZIONE
 - 5.2 COMPONENTI VERSIONE A MOBILE
 - 5.3 COMPONENTI VERSIONE A MURO
 - 5.4 INTERFACCIA UTENTE
 - 5.5 MASCHERINE
 - 5.6 MISURE MASCHERINE
 - 5.7 CIRCUITO MASCHERINE
- 6. INSTALLAZIONE**
 - 6.1 INSTALLAZIONE MASTER FLUX PLUS A MOBILE
 - 6.2 INSTALLAZIONE MASTER FLUX PLUS A PARETE
 - 6.3 COLLEGAMENTO CIRCUITI E ACCESSORI MASTER FLUX
 - 6.4 EVACUAZIONE GAS ESALATI
 - 6.4.1 COLLEGAMENTO DIRETTO ALL'ESTERNO DELLO STUDIO
 - 6.4.2 COLLEGAMENTO ALL'ASPIRATORE CHIRURGICO
- 7. FUNZIONAMENTO DEL DISPOSITIVO**
 - 7.1 COMANDI E DISPOSITIVI DI INTERFACCIA UTILIZZATORE
 - 7.2 ISTRUZIONI DI UTILIZZO
 - 7.3 RIANIMAZIONE CON IL MASTER FLUX PLUS
- 8. MANUTENZIONE**
 - 8.1 SOSTITUZIONE DELLE BOMBOLE
 - 8.1 PULIZIA
 - 8.2 MANUTENZIONE PROGRAMMATA
- 9. SEGNALAZIONI**
- 10. PROCEDURE PER SERVIZIO ED ASSISTENZA**

DESTINAZIONE D'USO

Il MASTER FLUX PLUS è un dispositivo per la somministrazione di una miscela di O₂ e N₂O al paziente, utilizzato nelle tecniche di sedazione cosciente /analgesia sedativa.

IMPIEGO

Nella miscela somministrata i valori di concentrazione sono:

O₂ ≥ 30%

N₂O ≤ 70%

La somministrazione è eseguita con una mascherina nasale, il paziente deve inspirare la miscela respirando attivamente dal naso.

La sedazione cosciente è indicata per tutti i pazienti dello studio odontoiatrico, sia adulti che bambini.

La sedazione cosciente permette ai pazienti di sottoporsi a cure odontoiatriche limitando la paura e lo stato ansioso che tutti i pazienti provano una volta entrati in uno studio odontoiatrico.

**LA SEDAZIONE COSCIENTE NON È INDICATA:**

- IN GRAVIDANZA

- NEI PAZIENTI TOSSICODIPENDENTI

- IN PRESENZA DI GRAVI INFEZIONI POLMONARI

- NEI SOGGETTI CON GRAVI MALATTIE MENTALI



Il MASTER FLUX PLUS deve essere utilizzato solo da personale medico, che abbia ricevuto una specificata preparazione.



Non utilizzare questo dispositivo per la somministrazione di anestesia generale o come parte o in combinazione con un sistema generale di anestesia.



La legge limita la vendita di questo dispositivo solo a medici e odontoiatri.

ATTENZIONE



Non tentare di riparare, modificare o calibrare questo dispositivo. La riparazione non autorizzata, l'alterazione o l'abuso di questo dispositivo incide negativamente sulle prestazioni e invalida la garanzia.



Prima di ogni utilizzo verificare il corretto collegamento dei gas di alimentazione



Il dispositivo somministra farmaci unicamente per la tecnica della sedazione cosciente



Le controindicazioni sull'utilizzo del farmaco sono riportate nella scheda di sicurezza e documentazione allegata alla fornitura del farmaco. Se non presente richiedere al fornitore del gas.



Non rimuovere la targhetta prodotto che riporta matricola e lotto di produzione.



Non sostituire i riduttori in dotazione con altri non forniti dal fabbricante

AIFA – DDL sull'uso extraospedaliero del protossido di azoto

L'utilizzo di protossido di azoto (N₂O) è permesso solo attraverso specifiche apparecchiature che impediscono l'erogazione di miscele ipossiche e solo in specifici ambienti con adeguato ricircolo d'aria.

Il farmaco, in ambiente extraospedaliero, è da utilizzarsi alla concentrazione massima del 50% in ossigeno (cioè non più del 50% di protossido di azoto e almeno 50% di ossigeno).

L'unica eccezione è rappresentata dalla sedazione cosciente praticata da esperti odontoiatri sedazionisti che, con il paziente sicuramente cosciente (come documentato dalla apertura della bocca), possono impostare, per brevi periodi di tempo, una erogazione a concentrazioni fino al 70%.

Il protossido di azoto è da decenni ampiamente utilizzato in ambito extraospedaliero, soprattutto in campo odontoiatrico, come analgesico ansiolitico. Non sono ad oggi state descritte gravi complicanze secondarie al suo utilizzo come analgesico ansiolitico in ambito extraospedaliero.

Il protossido di azoto deve essere utilizzato solo in presenza di personale medico o odontoiatra con adeguato training in rianimazione cardiopolmonare (BLS-D) e consapevole di come A) in caso di perdita di coscienza si debba immediatamente interrompere la somministrazione del protossido di azoto e di come B) in caso di apnea si debba immediatamente procedere a rendere pervie le vie aeree del paziente (per esempio con la triplice manovra di estensione del capo, sublussazione della mandibola e apertura della bocca) e eventualmente supportare la ventilazione del paziente (per esempio con il pallone auto espansibile e una mascherina facciale).

L'utilizzo del protossido di azoto (N₂O) in ambiente extraospedaliero, non deve essere associato all'utilizzo di altri farmaci anestetici, ipnotici, sedativi o antidolorifici maggiori se non in presenza di un anestesista rianimatore. L'utilizzo di protossido di azoto può invece precedere o seguire l'infiltrazione di anestetici locali, come per esempio in odontoiatria.

Il testo è valido per i dispositivi venduti in Italia.

TECNO-GAZ consiglia l'applicazione di questo testo per tutti gli utilizzatori del dispositivo, integrandolo con le normative vigenti nel paese di utilizzo.

L'utilizzo del dispositivo Master Flux Plus va abbinato all'uso del PULSIOSSIMETRO che deve essere routinario in corso di sedazione cosciente.

Il significato della lettura dei valori rilevati:



Livelli di saturazione di O ₂	Grado di ipossia
≥ 95%	Nessuna ipossia
90-94%	Ipossia lieve
85-89%	Ipossia moderata
84%	Ipossia grave

2.1 Marcatura di sicurezza

Il dispositivo è conforme alla Direttiva 93/42/CEE e successive modifiche e integrazioni. La dichiarazione di Conformità è allegata al dispositivo

2.2 Dispositivi di sicurezza

Il dispositivo è fornito di dispositivi di sicurezza:

- Se si riduce la pressione dell'ossigeno (O₂), l'erogazione di protossido di azoto (N₂O) si interrompe automaticamente.
- Un sistema di miscelazione incorporato regola l'N₂O in modo tale che nella miscela di gas sia sempre presente una quantità minima di O₂ pari almeno al 30%.
- Se il flusso della miscela di gas si interrompe, il paziente aspira aria dall'esterno, tramite un'apposita valvola di sicurezza.
- Se il flusso dovesse cambiare direzione, tornando verso il dispositivo, una valvola unidirezionale protegge il paziente da ri-respirazione dei gas esalati e da accumuli di anidride carbonica (CO₂).
- La manopola di impostazione del flusso controlla il flusso totale, regola automaticamente i flussi di ossigeno e protossido di azoto nella percentuale impostata.
- Il pulsante FLUSH (O₂), quando previsto, può essere impiegato per l'erogazione rapida di O₂ direttamente all'uscita dell'unità di dosaggio, permette di erogare alti flussi di ossigeno puro.

AVVERTENZE & NOZIONI UTILI



DURANTE LA SOMMINISTRAZIONE DI GAS È INDISPENSABILE:

- ESSERE SEMPRE PRESENTI,
- MANTENERE SOTTO CONTROLLO I FLUSSI DEI GAS;
- VERIFICANDO I VALORI DEL FLUSSO RIPORTATI SUI FLUSSIMETRI
- CONTROLLARE LA SACCA.

2.3 Movimentazione



Per muovere il mobile Master Flux Plus usare esclusivamente le maniglie in dotazione.



Figura 1

	<p>Non spingere il mobile senza usare le apposite maniglie.</p>
	<p>non sedersi o appoggiare pesi sopra il mobile.</p>
	<p>Prima di muovere il mobile riposizionare con cura mascherina e i tubi negli appositi sistemi di fissaggio, evitando inciampi o rotture.</p>

2.4 Smaltimento

Lo smaltimento dell'imballo, del dispositivo e dei singoli componenti deve avvenire nel rispetto delle norme vigenti nel paese di utilizzo, per il trattamento e l'eliminazione di rifiuti potenzialmente bio-contaminanti.

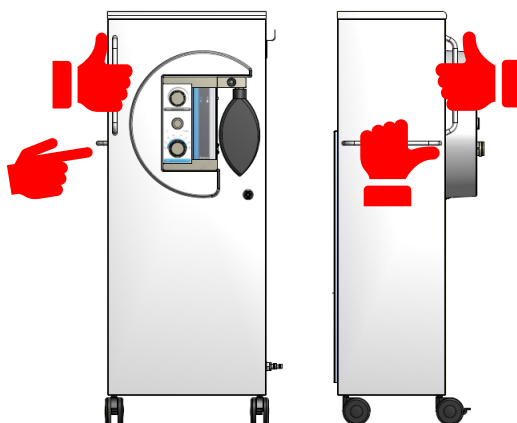
Non disperdere il materiale dell'imballo nell'ambiente.

Il dispositivo non contiene parti elettriche/elettroniche e non contiene batteria.

ALIMENTAZIONE

Pressione alimentazione Gas	(3,5 ÷ 6) bar (50 ÷ 87) PSI
Portata massima dispositivo	10 NI/min. (litri al minuto)

PESO MASTER FLUX PLUS A MOBILE:

Peso senza bombole	46 kg
Peso massimo sostenibile vano bombole piano ruote	180 kg
Peso massimo sostenibile vano bombole superiore	45 kg

BOMBOLE PER MASTER FLUX PLUS A MOBILE:

Altezza massima	950 mm
Diametro massimo	140 mm

PESO MASTER FLUX PLUS A PARETE:

Peso della scatola flussometrica	6,3 kg
----------------------------------	--------

FLUSSIMETRO

Ripetibilità	+/-10% portata indicata
--------------	-------------------------

Letture corretta: in linea con la parte superiore piatta.

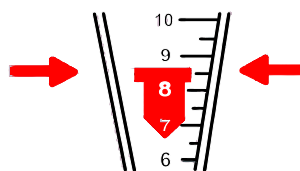

CONSUMI:

A seguire è indicato un esempio di consumo da prendere come riferimento teorico

BOMBOLA OSSIGENO MEDICALE CON CAPACITÀ 10 l.
CARICATA ALLA PRESSIONE DI 200 Bar

VOLUME DISPONIBILE	2000 Litri gassosi
--------------------	--------------------

BOMBOLA PROTOSSIDO DI AZOTO CON CAPACITÀ 10 l.
CARICATA CON 7 Kg DI GAS LIQUIDO

VOLUME DISPONIBILE	4600 Litri gassosi
--------------------	--------------------

IMPOSTANDO:

EROGAZIONE	10 NI/min.
MISCELAZIONE	50 %

AUTONOMIA:

OSSIGENO	400 min
PROTOSSIDO DI AZOTO	950 min



In base alle medie di consumo del gas TECNO-GAZ consiglia di sostituire la bombola di Protossido di Azoto ogni 2 bombole di Ossigeno.



Figura A



Figura B

04

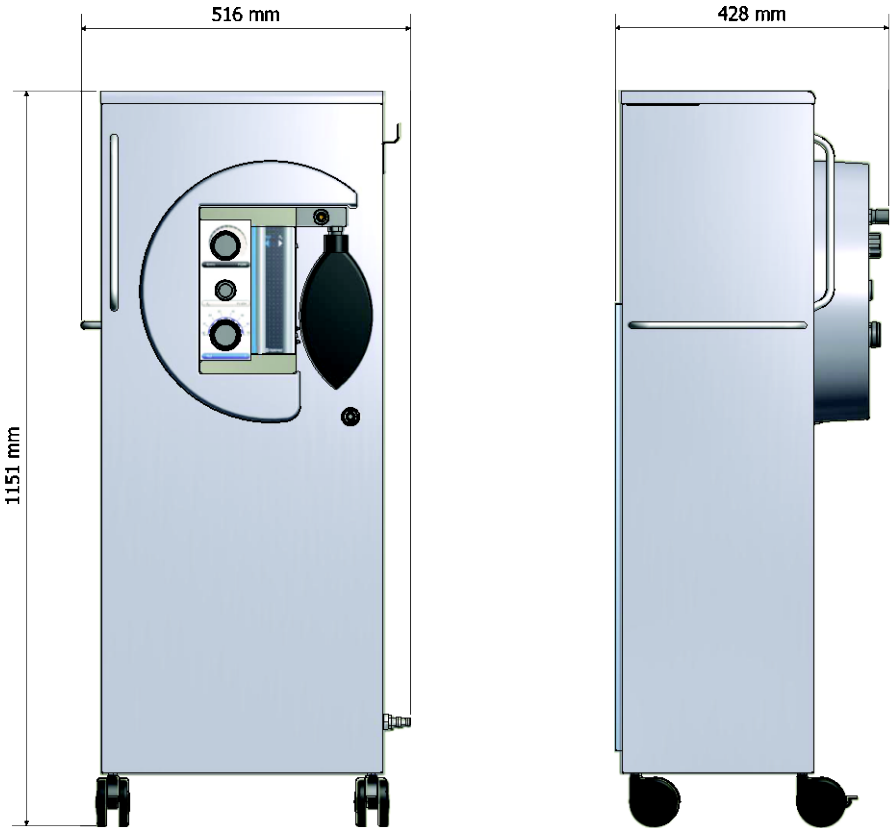
DISIMBALLAGGIO

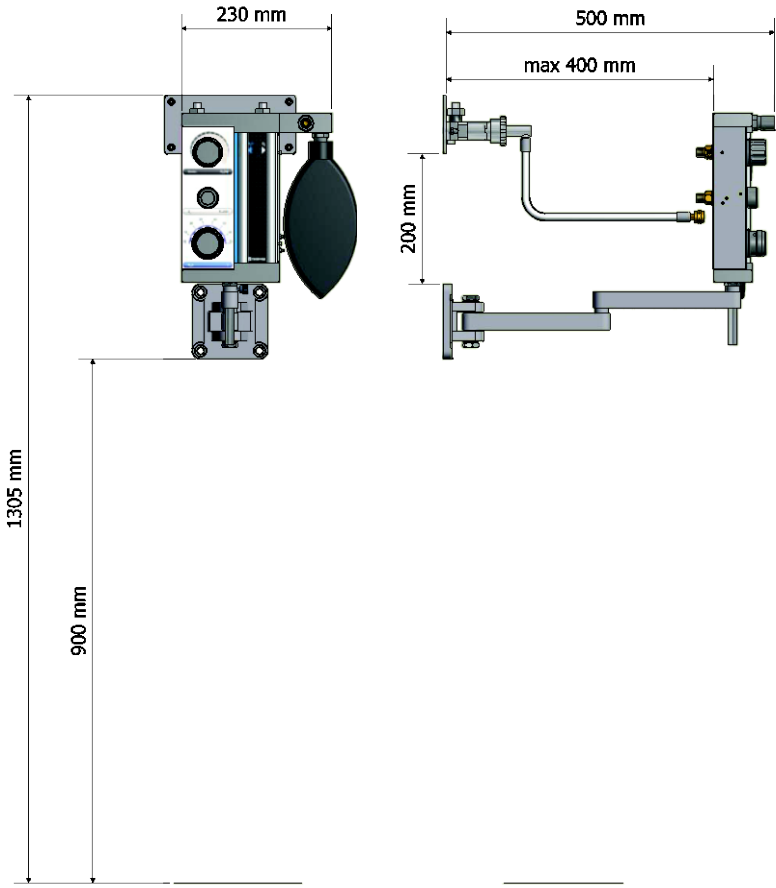

NON È CONSENTITO SOVRAPPORRE I MOBILI MASTER FLUX PLUS IMBALLATI



L'imballo non deve subire urti, deve essere maneggiato con cura evitando di farlo rotolare o farlo cadere.



Non utilizzare apparecchi che presentano danni evidenti dovuti al trasporto.



Togliere l'imballo e controllare lo stato dell'apparecchio.



L'imballo deve essere conservato per tutto il periodo di garanzia.
Il fabbricante non accetta resi senza imballo originale.



I dispositivi imballati devono essere custoditi in luoghi asciutti e a temperatura compresa tra +5°C e +40°C.

005

COMPONENTI

5.1

Elenco componenti in dotazione

ARTICOLO	MF010ZMF Master Flux Plus a muro con Riduttori con attacchi Ossigeno AFNOR e Protossido Azoto UNI	1601ASD Master Flux Plus a muro con Riduttori con attacchi Ossigeno e Protossido Azoto DIN	1601AS Master Flux Plus a muro con Riduttori con attacchi Ossigeno e Protossido Azoto UNI	MF009ZMF Master Flux Plus a mobile senza kit riduttori	MF006ZMF Master Flux Plus a mobile con Riduttori con attacchi Ossigeno AFNOR e Protossido Azoto UNI	1600ASD Master Flux Plus a mobile con Riduttori con attacchi Ossigeno e Protossido Azoto DIN	1600ASF Master Flux Plus a mobile con Riduttori con attacchi Ossigeno e Protossido Azoto AFNOR	1600AS Master Flux Plus a mobile con Riduttori con attacchi Ossigeno e Protossido Azoto UNI
MOBILE	SMFA301	SMFA301	SMFA301	2ZMFA0020	2ZMFA0020	2ZMFA0020	2ZMFA0020	2ZMFA0020
KIT MASTER	22ZMFA0065	22ZMFA0063	22ZMFA0062	2ZMFA0057	2ZMFA0059	22ZMFA0058	22ZMFA0061	22MFA0060
RIDUTTORE N₂O	SMFA360	SMFA360	SMFA360		MF011ZMF	MF011ZMF	MK005ZMF	MF011ZMF
RIDUTTORE O₂	SMFA361	SMFA358	MF003ZMF		1513A4F	1513A4D	1513A4F	1513A4
MASCHERINE	<p>MF820ZMF Master Flux circuito</p> <p>MF824ZMF Circuito aspirazione Master Flux Plus (new)</p> <p>MF835ZMF Intelliflux 1 maschera completa Master Flux plus 0-4 anni</p> <p>MF836ZMF Intelliflux 2 maschera completa Master Flux plus 4-10 anni</p> <p>MF837ZMF Intelliflux 3 maschera completa Master Flux plus >10 anni</p>							



Figura 2

FIGURA	POSIZIONE	Q.TA'	CODICE	DESCRIZIONE
3	1	1	SMFA144	COPERTURA IN PLASTICA
	2	1	SMFA506	SCATOLA FLUSSOMETRICA
	3	3	SMFA223	DISTANZIATORE
	4	3	CM25021	VITE AD ALETTE M5
	5	3	3MECQ0010	DISTANZIATORE
	6	3	CM20015	RONDELLA
	7	3	CM25019	DADO AD ALETTE M6
	9	2	SMFA237	PORTAGOMMA ELIMINAZIONE GAS

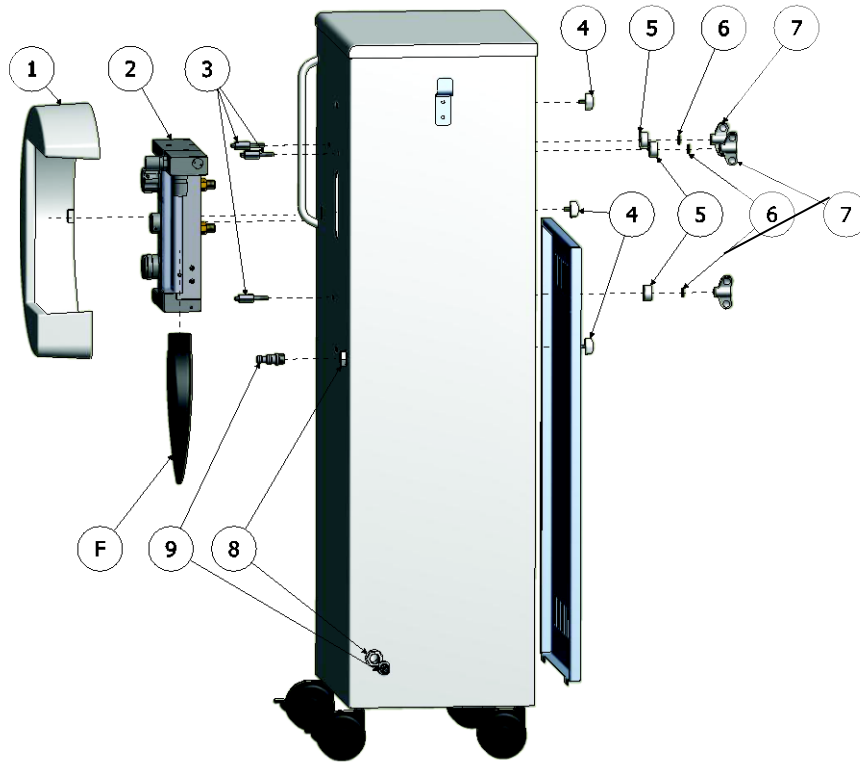

Figura 3-4

A MURO (Figura 3-4)

FIGURA	POSIZIONE	Q.TA'	CODICE	DESCRIZIONE
4	10	1	SMFA313	PERNO
	11	1	SMFA364	TUBO O ₂
	12	1	SMFA365	TUBO N ₂ O
	13	1	SMFA301	SUPPORTO A PARETE
	14	1	SMFA501	PIASTRA A PARETE
	15	1	CM30011	MANOPOLA FISSAGGIO PERNO

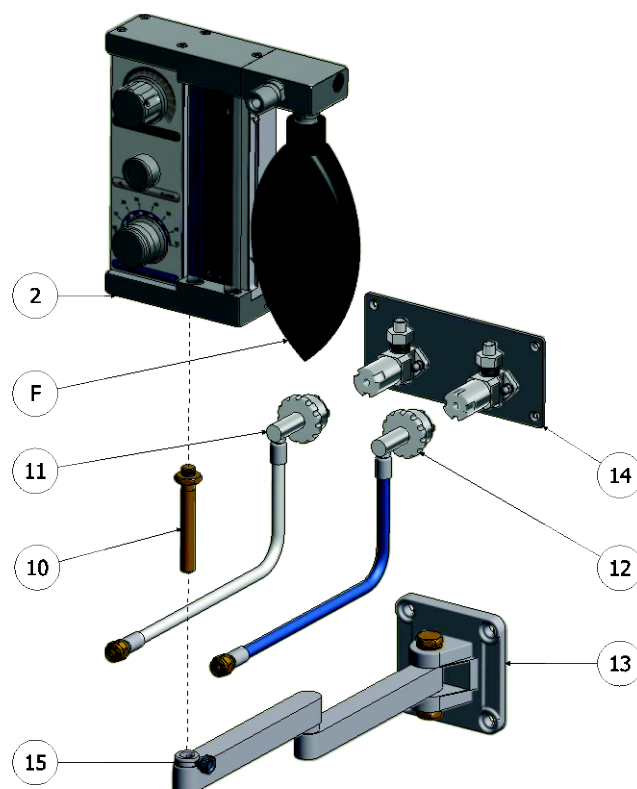

Figura 5

A	Manopola FLOW
B	Pulsante FLUSH
C	Manopola % N ₂ O
D	Flussimetro N ₂ O
E	Flussimetro O ₂
F	Pallone reservoir
G	Portagomma per collegamento maschera

5.5

MASCHERINE

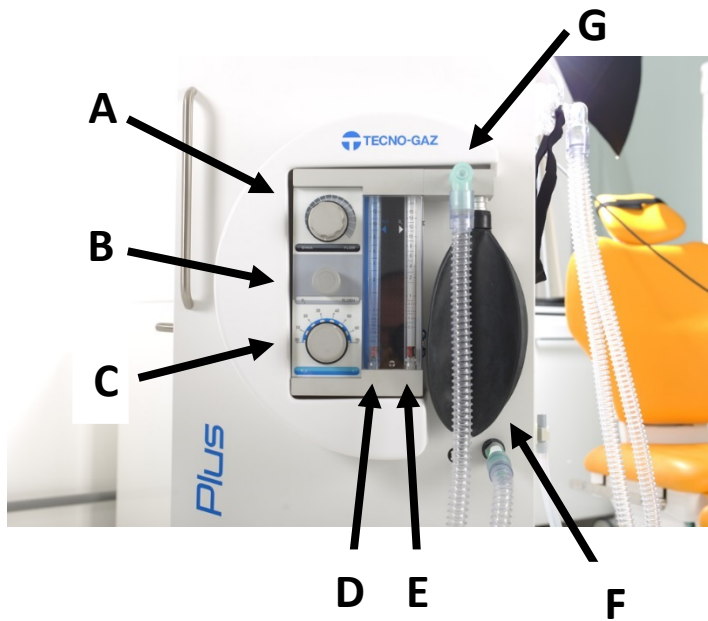

Figura 6

①	Zona di appoggio per la fronte del paziente
②	Entrata del gas con valvola di non ritorno
③	Uscita del gas con valvola di non ritorno + freccia stampata sul PC per indicare la direzione del flusso
④	Fascia elastica in velcro con ganci in plastica

5.6

MISURE MASCHERINE

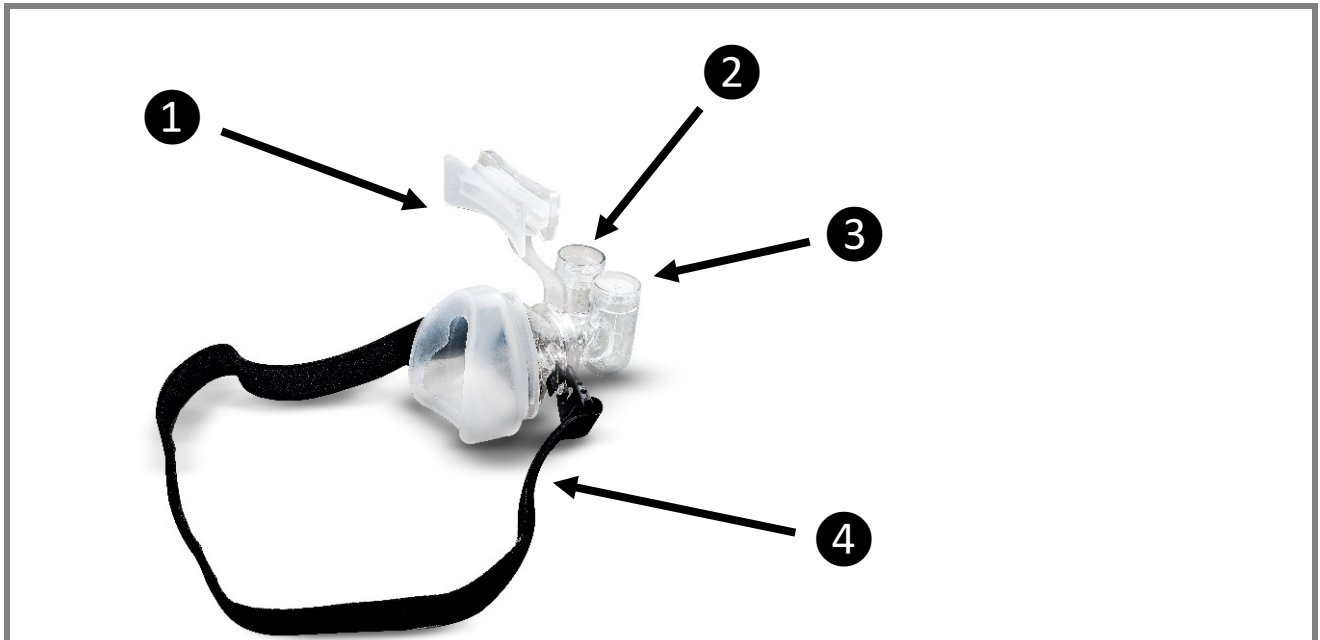
MF835ZMF	MF836ZMF	MF837ZMF	MF838ZMF
MASCHERA 1	MASCHERA 2	MASCHERA 3	MASCHERA 4
0-4 anni	4-10 anni	>10 anni	

Figura 7



Figura 8

CIRCUITO COMPLETO DI MASCHERE



Figura 9



Per i ricambi dei componenti singoli, vedere sul manuale d'uso di "Circuiti e maschere".

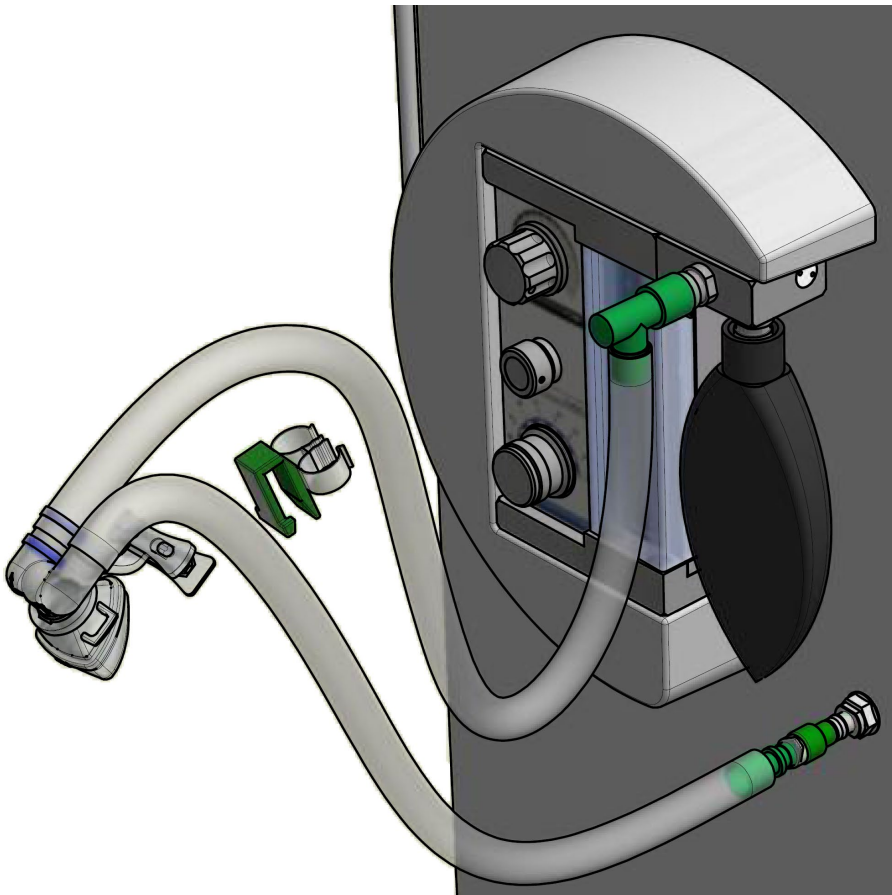

Togliere l'imballo e controllare lo stato dell'apparecchio.
Non utilizzare apparecchi che presentano danni evidenti dovuti al trasporto.

MONTAGGIO SCATOLA FLUSSOMETRICA (Figura 2)

vedi Guida rapida allegata 0ZMFI0007

Avvitare i 3 distanziatori in acciaio (3) sulla scatola flussometrica (2).

Togliere le protezioni dai nipples di alimentazione della scatola flussometrica.

Montare la scatola flussometrica sul mobile inserendo i distanziatori in acciaio (3) negli appositi fori del mobile, fissandoli al mobile utilizzando 3 distanziatori in plastica (5), 3 rondelle (6) e i tre dadi ad alette (7) in dotazione.

MONTAGGIO COVER FRONTALE (Figura 2 Pos 1)

vedi Guida rapida allegata 0ZMFI0007

Posizionare la cover in plastica in prossimità dei tre fori sul mobile.

Fissare la cover in plastica avvitando le tre viti ad alette (4) in dotazione.

MONTAGGIO PORTAGOMMA SCARICO (Figura 2 Pos 9)

vedi Guida rapida allegata 0ZMFI0007

Se si utilizza il tubo di scarico dei gas esalati, avvitare il portagomma in dotazione ai raccordi in plastica.

MONTAGGIO BOMBOLE (NON IN DOTAZIONE) (Figura 10)

Fissare i riduttori alle bombole (vedi manuale istruzione dei riduttori).

Per bombole da 5 lt inserire il ripiano e fissarlo tramite gli appositi fermi.

Per le bombole da 10 e 14 lt posizionare il ripiano sul fondo del mobile.

I manometri dei riduttori (M) devono essere posizionati in modo da essere visibili dall'operatore.

Bloccare le bombole al mobile utilizzando l'apposita fascia in velcro in dotazione.

Avvitare il dado del tubo del riduttore O₂ (R1) con il nipplo di alimentazione della scatola flussometrica (I) (FILETTATURA DESTRA).

Avvitare il dado terminale del tubo del riduttore N₂O (R2) con il nipplo di alimentazione della scatola flussometrica (H) (FILETTATURA SINISTRA).

Chiudere lo sportello posteriore tramite i due magneti posti sulla parte superiore.



Figura 10

FIGURA	POSIZIONE	Q.TA'	CODICE	DESCRIZIONE
6	R1	1	MF847ZMF	RIDUTTORE O ₂ (ITA)
	R2	1	MF011ZMF	RIDUTTORE N ₂ O (ITA)
	L	1		VALVOLA
	M	1		MANOMETRO

6.2

INSTALLAZIONE MASTER FLUX PLUS A PARETE

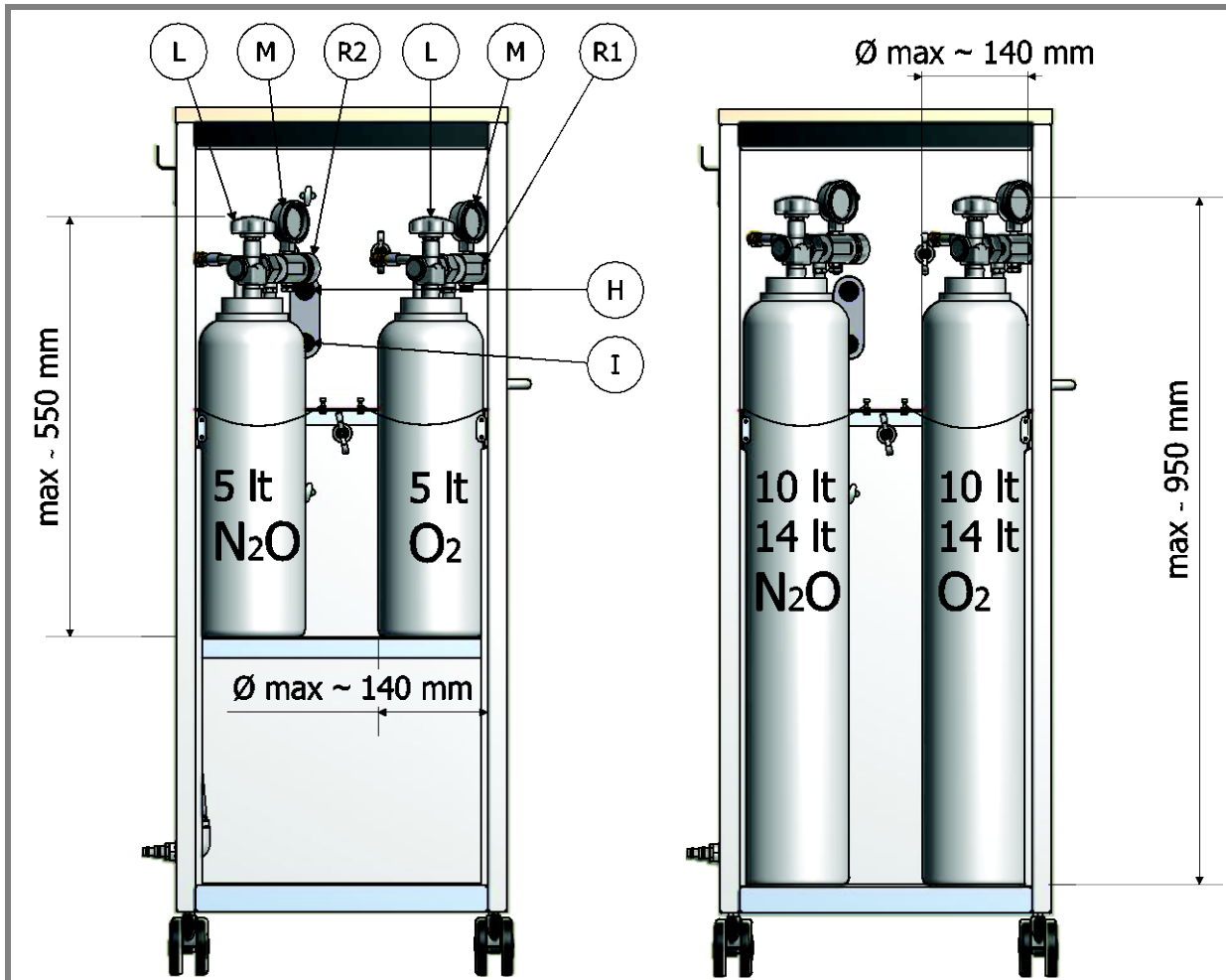
Figura 11



Figura 12

(RIFERIMENTI FIGURA 5, 10)

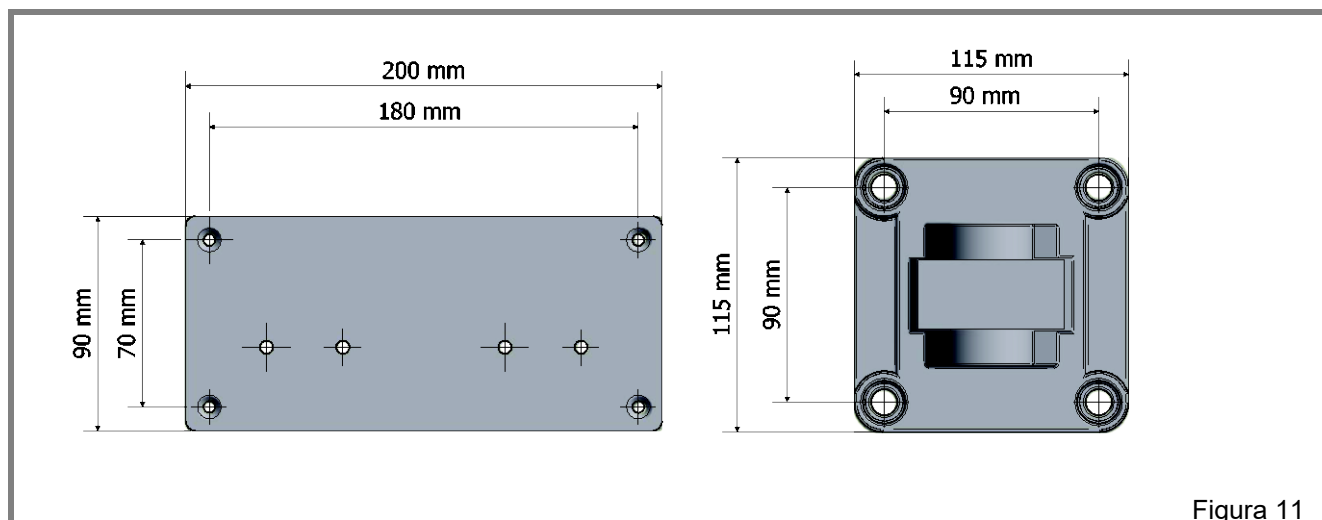
Fissare il SUPPORTO MASTER FLUX PLUS a parete (Pos13) utilizzando n.4 tasselli per parete $\varnothing 14$ mm M8.

Fissare la PIASTRA MASTER FLUX PLUS a parete (Pos14) con n.4 tasselli per parete $\varnothing 8$ mm.

Avvitare alla base della scatola flussometrica il perno (Pos10).

Inserire il perno nella parte finale del supporto (Pos15).

Bloccare il perno al supporto con l'apposita manopola filettata (Pos15).

Avvitare il dado del tubo O₂ (Pos11) con il nipple di alimentazione O₂ sulla scatola flussometrica (I) (filettatura DESTRA).

Collegare il dado del tubo N₂O (Pos12) con il nipple di alimentazione N₂O posto sulla scatola flussometrica (H) (filettatura SINISTRA).

Collegare le estremità libere dei tubi alle prese a muro (premere gli innesti e ruotare per bloccare l'innesto alla presa).

NOTE SULL'IMPIANTO CENTRALIZZATO



L'installazione deve essere eseguita da tecnici specializzati, l'impianto centralizzato deve essere eseguito in conformità alle direttive vigenti Direttiva Europea 93/42/CE

Collegare la presa a parete al punto equipotenziale dell'impianto elettrico, con i connettori a occhiello in dotazione.

I riduttori in dotazione devono essere collegati alle bombole dell'impianto centralizzato.

L'uscita del riduttore **N₂O** comprende un tubo flessibile alla cui estremità è graffato un raccordo maschio con filettatura **1/4" G** per il collegamento all'impianto.

L'uscita del riduttore **O₂** comprende un tubo flessibile alla cui estremità è graffato un raccordo maschio con filettatura **1/8" G** per il collegamento all'impianto.

La piastra fissaggio non è in dotazione.

6.3

COLLEGAMENTO CIRCUITI E ACCESSORI MASTER FLUX PLUS:



Figura 13

FIGURA	POSIZIONE	Q.TA'	CODICE	DESCRIZIONE
8	A	1		MANOPOLA ' FLOW '
	B	1		PULSANTE ' FLUSH '
	C	1		MANOPOLA ' % N2O '
	D	1		INDICATORE DI PORTATA N2O
	E	1		INDICATORE DI PORTATA O2
	F	1	3MEDN0002	SACCA ANESTESIA
	G	1		PORTAGOMMA COLLEGAMENTO MASCHERA
	H	1		NIPPLE N2O
	I	1		NIPPLE O2

Connettere il Pallone in gomma (F) alla scatola flussometrica, inserendolo a pressione nell'apposito portagomma.

Collegare il tubo, ingresso gas, del circuito mascherina al portagomma (G).

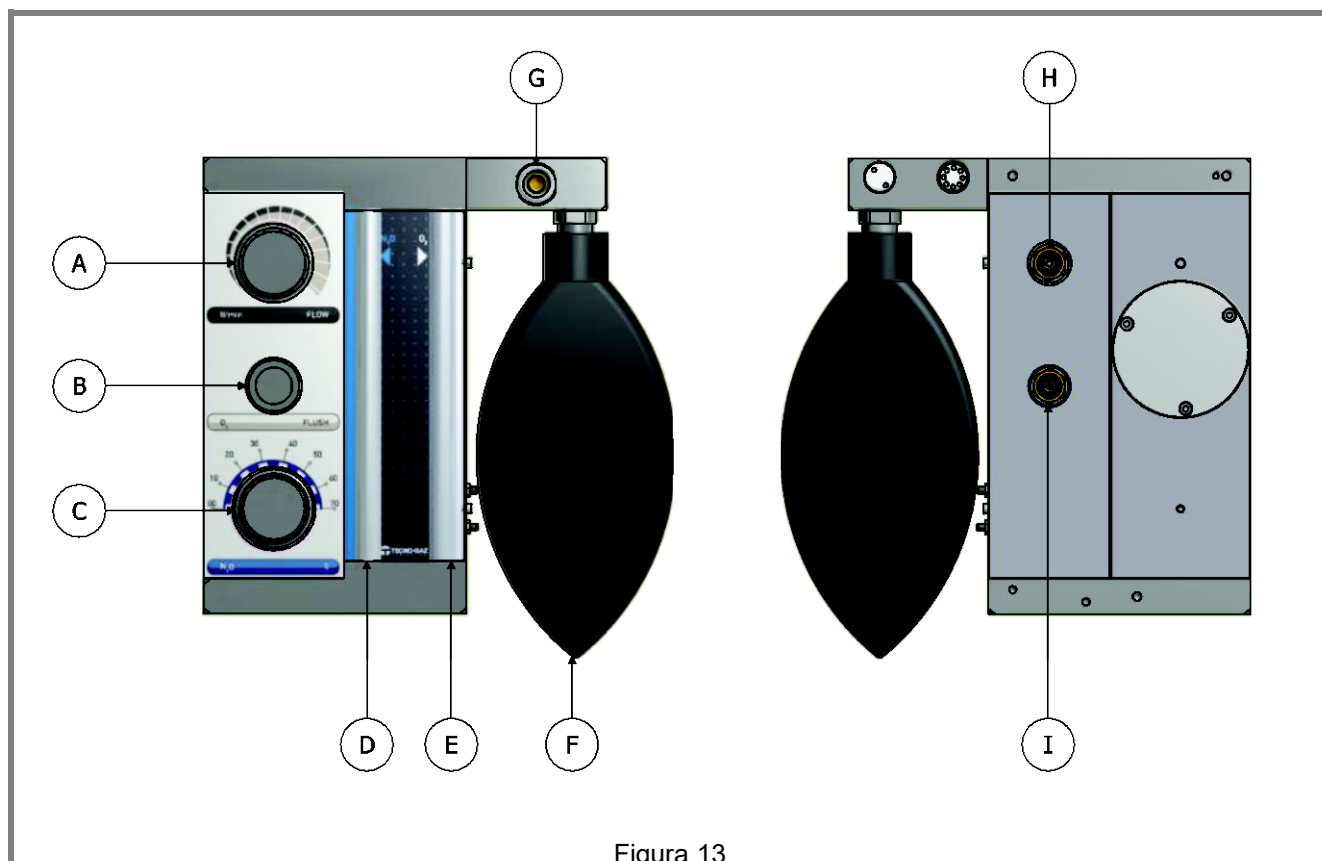
Il tubo, scarico gas, verrà collegato, con modalità differenti, in base al tipo di evacuazione gas utilizzato. (Vedi par 6.4 - EVACUAZIONE GAS ESALATI).

6.4 EVACUAZIONE GAS ESALATI:

Per la sicurezza dell'ambiente di lavoro e degli operatori, i gas esalati devono essere portati all'esterno dell'ambiente di lavoro.

Per scaricare i gas all'esterno possono essere utilizzati due sistemi:

- Collegamento diretto all'esterno dello studio
- Collegamento all'aspiratore chirurgico.

È importante valutare:

- L'idoneità dell'aspiratore all'evacuazione dei gas (N₂O e O₂)
- Lo scarico dell'aspiratore deve essere esterno e areato.

Verificare la conformità alle normative vigenti nel paese di utilizzo.

6.4.1 COLLEGAMENTO DIRETTO ALL'ESTERNO DELLO STUDIO

MASTER FLUX PLUS A MOBILE

Avvitare i portagomma (Figura 2 Pos 8/9) al mobile.

Eliminare la valvola in dotazione.

Collegare il tubo, scarico gas del circuito maschera, al portagomma (Figura 15).

Collegare il tubo spiralato, evacuazione gas (Figura 14), al portagomma del mobile.

Collocare all'esterno l'estremità del tubo spiralato e verificare la presenza del filtro finale, (Figura 14 Pos 34).

MASTER FLUX PLUS A MURO

Collegare il tubo, scarico gas del circuito maschera al portagomma (Figura 14 Pos 36).

Collocare all'esterno l'estremità del tubo spiralato e verificare la presenza del filtro finale (Figura 14 Pos 34).



FIGURA	POSIZIONE	Q.TA'	CODICE	DESCRIZIONE
9	34	1	SMFA197	FILTRO - SMFA260
	35	1		TUBO - SMFA199
	36	1		RACCORDO - SMFA257



Figura 15

6.4.2 COLLEGAMENTO ALL'ASPIRATORE CHIRURGICO

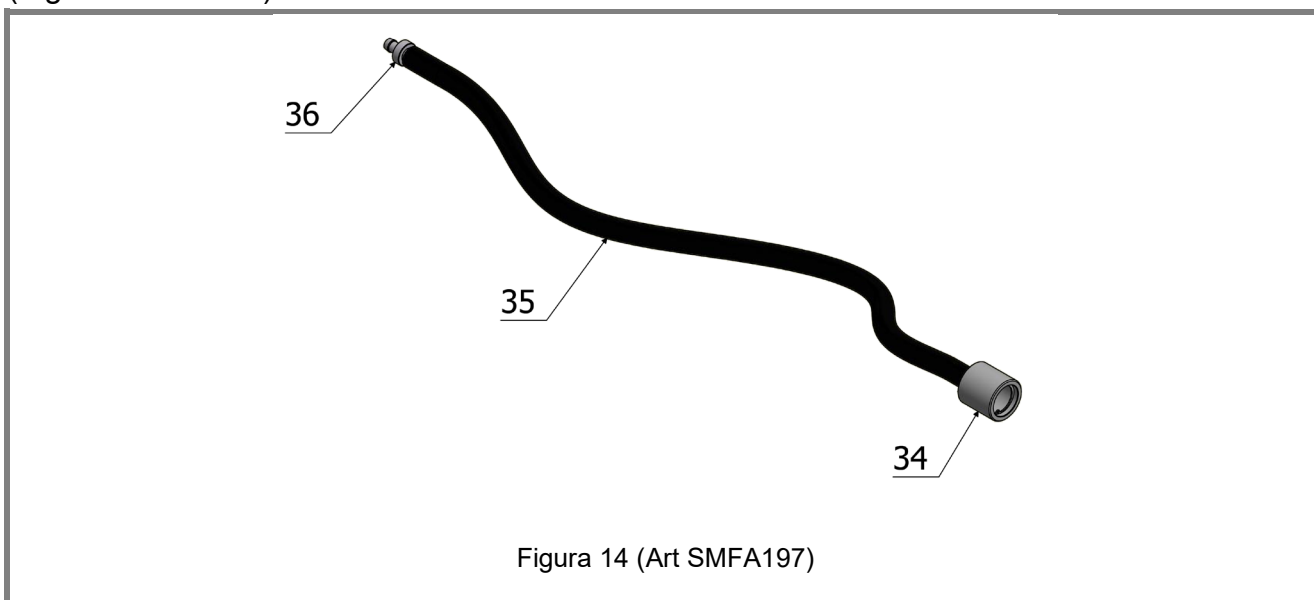
MASTER FLUX PLUS A MOBILE

Avvitare i portagomma (Figura 2 Pos 8/9) al mobile.
 Collegare il tubo, scarico gas del circuito maschera, al portagomma (Figura 17).
 Collegare il circuito aspirazione (Figura 16), al portagomma del mobile.
 Collegare la valvola al tubo dell'aspiratore chirurgico (Ø11).

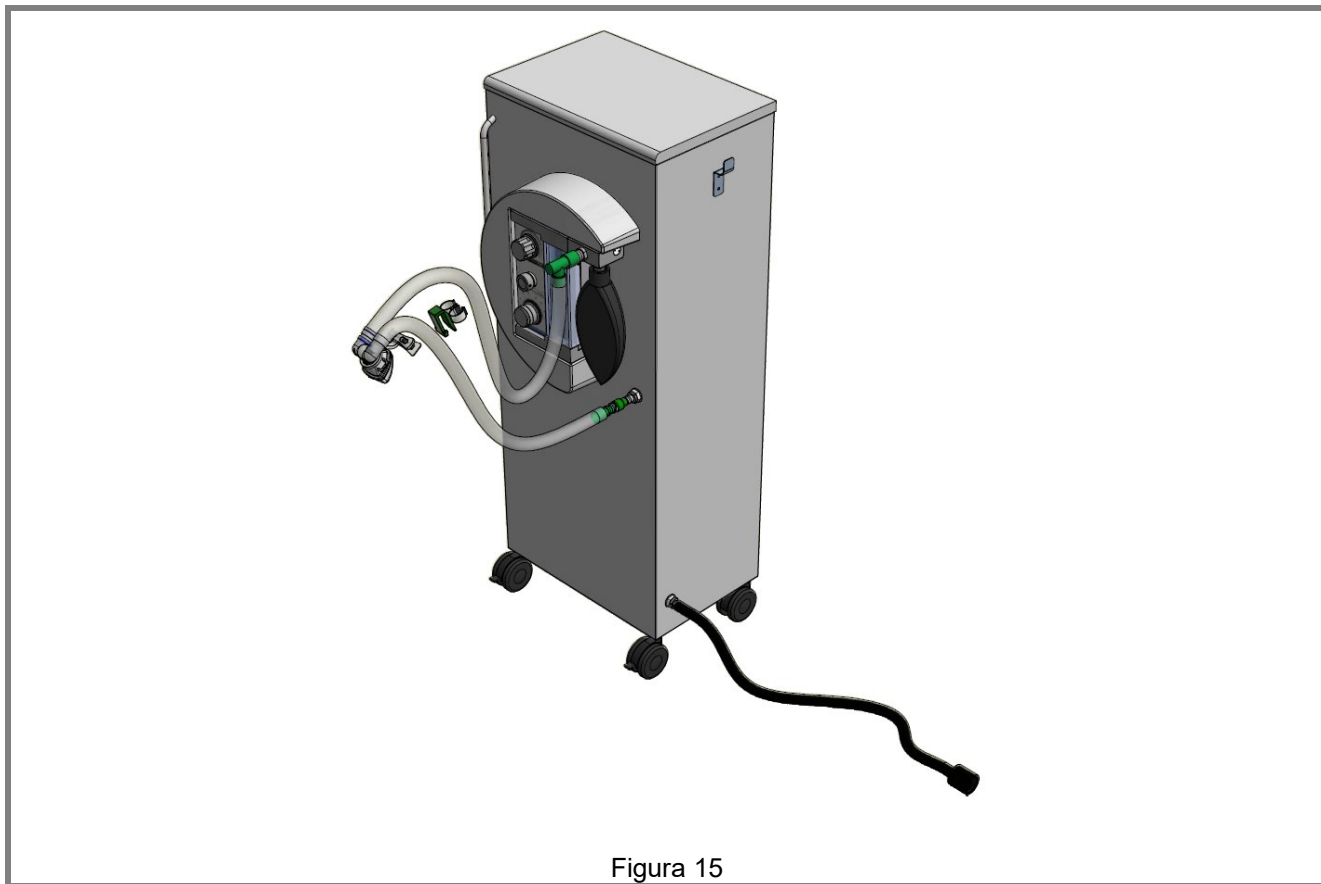
MASTER FLUX PLUS A MURO

Togliere il tubo (Figura 16 Pos 43)
 Collegare il tubo, scarico gas del circuito maschera, alla valvola (Figura 16 Pos 44).
 Collegare la valvola al tubo dell'aspiratore chirurgico (Ø11).

REGOLAZIONE DELLA VALVOLA

Ruotare la ghiera forata della valvola fino alla chiusura dei fori (Figura 16 Pos 44).
 Avviare l'erogazione dei gas impostando ~10 l/min.
 Avviare l'aspiratore chirurgico, impostare il valore minimo di aspirazione.
 Osservare il pallone (Figura 13 Pos F).
 Ruotare la ghiera forata della valvola aprendo progressivamente i fori fino ad ottenere lo stato ideale del pallone "MEZZO PIENO MEZZO VUOTO".

ATTENZIONE

Variando i flussi erogati, può essere necessario, regolare i corretti flussi di aspirazione dei gas esalati.



Figura 16 (Art MF824ZMF)

FIGURA	POSIZIONE	Q.TA'	DESCRIZIONE
9A	41	1	RIDUZIONE
	42	1	PARTE TERMINALE
	43	2	TUBI
	44	1	VALVOLA

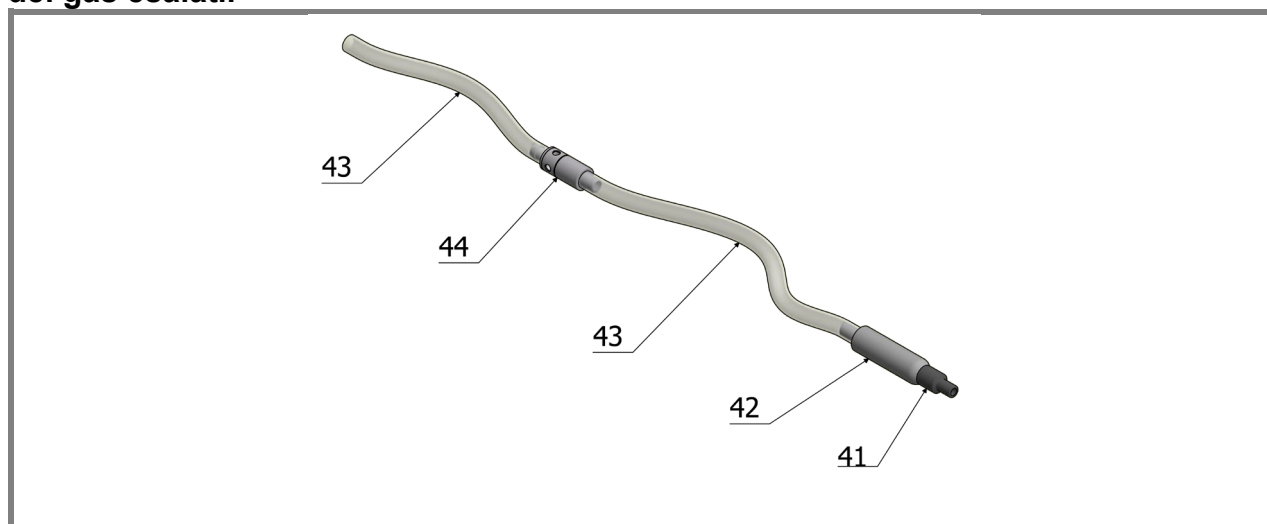

Figura 17

7 FUNZIONAMENTO DEL DISPOSITIVO

7.1 COMANDI E DIPOSITIVI DI INTERFACCIA UTILIZZATORE

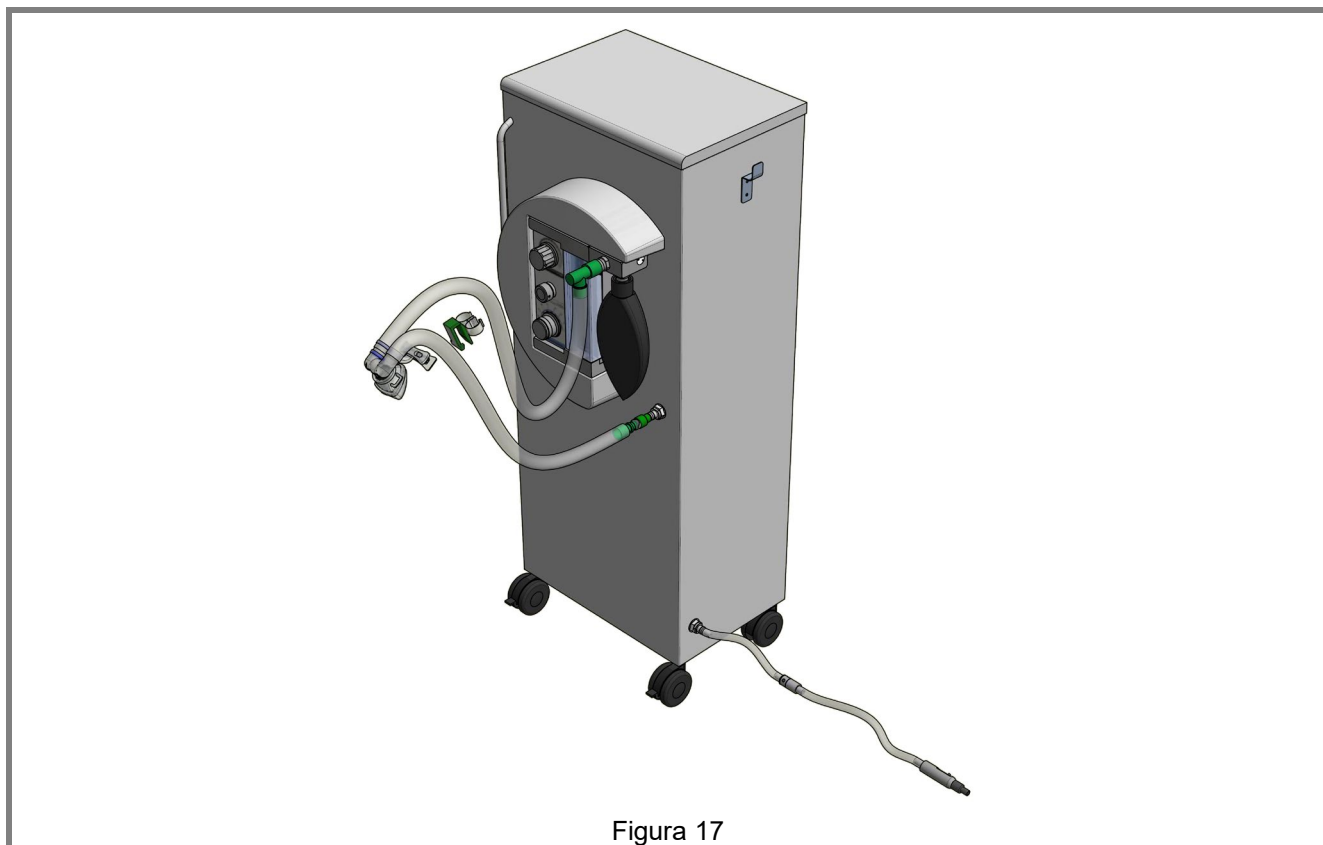

Figura 18

TASTI COMANDO (FIGURA 10)

A	MANOPOLA FLOW - REGOLAZIONE FLUSSO EROGATO
B	PULSANTE DI EMERGENZA FLUSH - EROGAZIONE SOLO OSSIGENO
C	MANOPOLA REGOLAZIONE % PROTOSSIDO DI AZOTO

ELEMENTI DI CONTROLLO

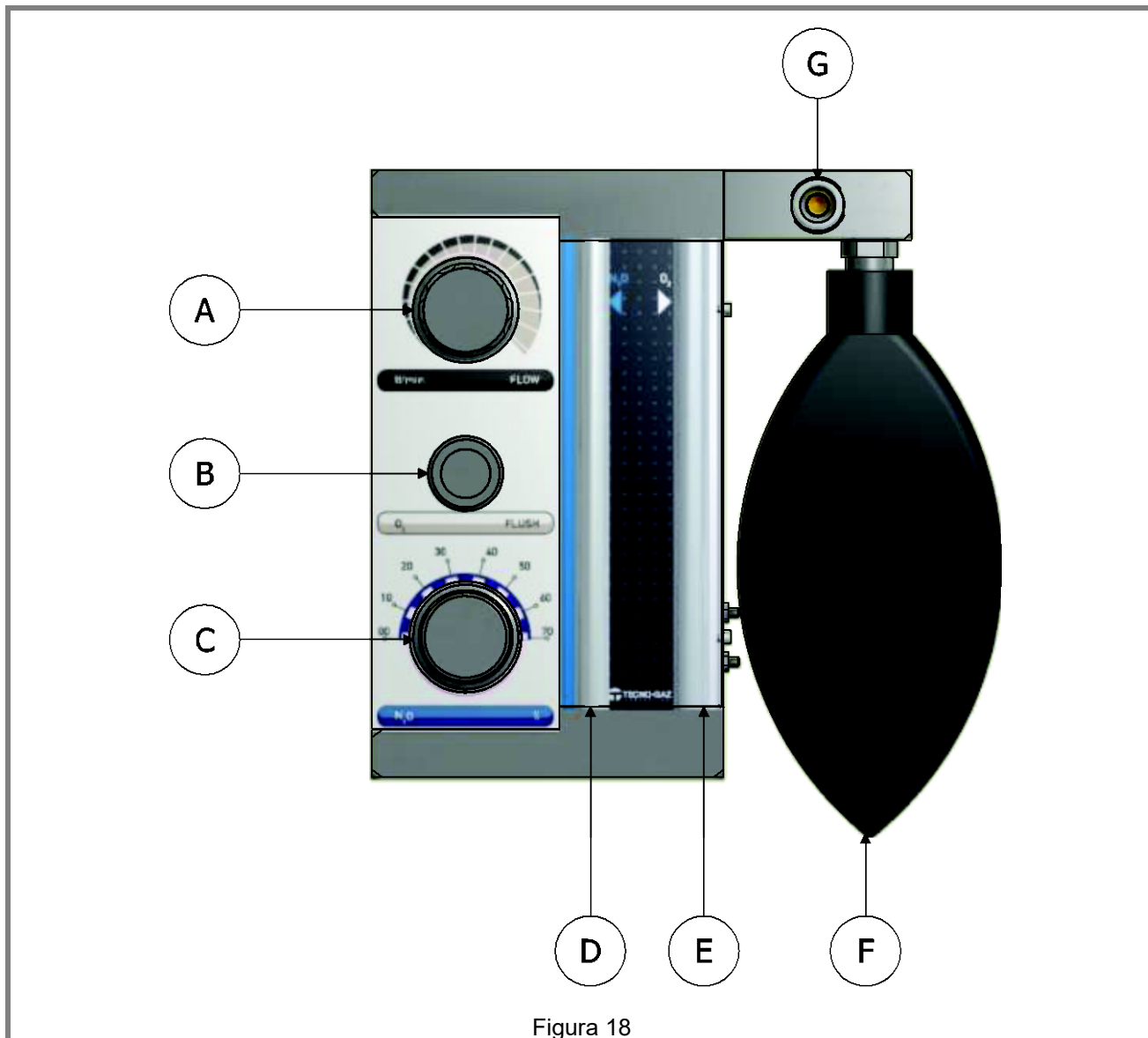
E	FLUSSO OSSIGENO PURO
D	FLUSSO PROTOSSIDO DI AZOTO PURO
F	PALLONE (VERIFICA - FLUSSO IDONEO AL PAZIENTE)

Prima di iniziare ad utilizzare il dispositivo MASTER FLUX PLUS nella versione a mobile, bloccare le ruote munite di freno premendo verso il basso le apposite linguette.

Nel caso si rendesse necessario spostare l'apparecchio (ad esempio da una stanza ad un'altra) sbloccare le ruote e spingere delicatamente il dispositivo utilizzando le maniglie vedi paragrafo 2.3



Evitare urti e movimenti bruschi che potrebbero causare cadute accidentali.



Spostare e posizionare il MASTER FLUX PLUS solo su superfici non inclinate e lisce.



Verificare la stabilità delle bombole e il corretto fissaggio



Chiudere le bombole prima di movimentare il dispositivo.



Non usare le maniglie per sollevare il dispositivo.



Non trascinare il dispositivo utilizzando le maniglie.



Non esporre i comandi a urti involontari.

Durante l'utilizzo del MASTER FLUX PLUS nella versione a muro, è possibile spostare ed orientare la scatola flussometrica a proprio piacimento, impugnando l'apposita maniglia (Figura 4 Pos. 10).



NON APPOGGIARSI E NON APPOGGIARE ALCUN OGGETTO ALLA SCATOLA FLUSSOMETRICA (SIA NELLA VERSIONE A MOBILE CHE IN QUELLA A MURO).

NON FORZARE IL BRACCETTO NELLA VERSIONE A MURO.



APRIRE LENTAMENTE LE VALVOLE DELLE BOMBOLE O₂ E N₂O RUOTANDO IN SENSO ANTIORARIO I RUBINETTI (Figura 10 Pos L).

Leggere la pressione sui manometri dei riduttori di pressione, (vedi DATI TECNICI) per stimare l'autonomia della bombola di ossigeno.

Verificare che il pallone e i tubi siano ben inseriti nei loro raccordi.

Scegliere la mascherina idonea al paziente.

Posizionare la mascherina facendola aderire al contorno del naso del paziente.

Fissare la mascherina tramite il blocca-tubo a scorsioio dietro al poggiatesta della poltrona.

Verificare che i tubi del circuito maschera non subiscano pieghe o strozzature.

L'operatore si deve posizionare in modo da avere il controllo visivo di:

- **PALLONE IN GOMMA** (Figura 18 Pos. F).
- **FLUSSIMETRI** (Figura 18 Pos. D, E).



DURANTE LA TERAPIA CONTROLLARE COSTANTEMENTE I FLUSSI VISUALIZZATI DALLE FLUSSIMETRI (Figura 13 Pos. D, E).



PRIMA DI ALLONTANARSI DAL PAZIENTE, ANCHE PER BREVI PERIODI, INTERROMPERE LA SEDAZIONE.

Controllare che l'indice della manopola (Figura 18 Pos C) % di N₂O indichi 0.

Somministrare, servendoci della manopola FLOW (Figura 18 Pos A), un flusso di 3 Lt/min di ossigeno per 30 secondi.

COMUNICARE AL PAZIENTE DI INSPIRARE ED ESPIRARE CON IL NASO.

Utilizzare la manopola **FLOW**, per regolare il flusso.

Variare progressivamente il flusso, valutare lo stato del pallone (Figura 18 Pos F), il pallone deve assumere una forma che noi definiremo di **mezzo pieno mezzo vuoto**.

Fare respirare il paziente almeno un minuto prima di valutare il flusso.

Determinato il flusso ideale, determinato dalla capacità polmonare del paziente, regolare la valvola di eliminazione gas come indicato nel paragrafo 6.4 'Evacuazione gas esalati'.

Con la manopola % (Figura 18 Pos C) è possibile variare la percentuale di protossido di azoto.

I flussimetri visualizzano i litri/minuti di Protossido di azoto e Ossigeno erogati.

La somma delle due portate è quella impostata inizialmente in base alla capacità respiratoria del paziente.



Le indicazioni sotto riportate sono esempi di somministrazione.

Ogni utilizzatore deve impostare il flusso e la percentuale in base al paziente che sottopone alla somministrazione del farmaco.

SPECIFICHE DI TERAPIA PER BAMBINI:	SPECIFICHE DI TERAPIA PER ADULTI:
<p>Il flusso per i BAMBINI si aggira sui 4-5 Lt/min.</p> <ul style="list-style-type: none"> - Ruotare in senso orario la manopola "FLOW" impostando un flusso di 4/5 l/min e lasciare inspirare per ~1 minuto. - Verificare il flusso impostato sulla colonnina O₂ (Figura 18 Pos E). - Il pallone deve essere mezzo pieno mezzo vuoto. 	<p>Il flusso per gli ADULTI si aggira sui 6-8 Lt/min.</p> <ul style="list-style-type: none"> - Ruotare in senso orario la manopola "FLOW" impostando un flusso di 6-8 l/min e lasciare inspirare per ~1 minuto. - Verificare il flusso impostato sulla colonnina O₂ (Figura 18 Pos E). - Il pallone deve essere mezzo pieno mezzo vuoto.

Con la manopola (Figura 18 Pos C) % di N₂O somministrare il protossido di azoto, impostare il **20%**, attendere alcuni minuti e osservare le reazioni del paziente.

Se il paziente non è sedato aumentare progressivamente la percentuale (es 30%).

LA PERCENTUALE DI PROTOSSIDO DI AZOTO SOMMINISTRATA AL PAZIENTE DEVE ESSERE LA PIÙ BASSA POSSIBILE PER OTTENERE UNA BUONA SEDAZIONE (BASE LINE).

Stabilito il BASE LINE del paziente, segnare il valore del FLUSSO e la % di N₂O sulla cartella clinica, questi dati saranno utili nelle sedute successive.



LA MISCELA DI GAS SOMMINISTRATA AL PAZIENTE:
NON DEVE ESSERE SUPERIORE AL 70% DI PROTOSSIDO DI AZOTO
NON DEVE ESSERE INFERIORE AL 30% DI OSSIGENO



Se il paziente accusa sintomi di malessere (nausea, vertigini, mal di testa), interrompere IMMEDIATAMENTE la terapia.

Sul dispositivo è presente il pulsante “FLUSH” (Figura 13 Pos B).

- Premendo questo pulsante il pallone si riempirà di ossigeno.
- Premendo il pallone somministreremo quantità elevate di ossigeno puro al paziente.

FINE TERAPIA

La terapia si concluderà quando il medico odontoiatra termina l'intervento sul paziente.

Per concludere la terapia:

- Interrompere l'erogazione di PROTOSSIDO DI AZOTO ruotando la manopola (Figura 18 Pos C) % di N₂O (in senso antiorario) a fine corsa (0%).
- SOMMINISTRARE (COME ALL'INIZIO DELLA TERAPIA) UN FLUSSO DI 3 LT/MIN DI OSSIGENO PER 2 MINUTI
- INTERROMPERE L'EROGAZIONE DI OSSIGENO RUOTANDO LA MANOPOLA (Figura 18 Pos A) FLOW (IN SENSO ANTIORARIO) A FINE CORSA.
- Allentare il blocca-tubo a scorcio e togliere la mascherina al paziente.

Prima di dimettere il paziente tenerlo in osservazione (sala d'attesa) per circa 5÷10 minuti.

Il medico potrebbe ritenere necessario aumentare il tempo di osservazione.

CHIUSURA BOMBOLE



Terminato l'utilizzo del dispositivo è **IMPORTANTE** chiudere le bombole.



Chiudere il rubinetto della bombola del Protossido (N₂O), ruotandolo in senso orario.



Chiudere il rubinetto della bombola dell'Ossigeno (O₂), ruotandolo in senso orario

DEPOSITO BOMBOLE



A fine giornata stoccare le bombole in un deposito conforme alle leggi vigenti

7.3 RIANIMAZIONE CON IL MASTER FLUX PLUS

*(KIT Art. 1504/A Non in dotazione vedi Fig 19)



Le operazioni di rianimazione con IL MASTER FLUX PLUS, deve essere effettuata con la manopola %N₂O regolazione percentuale protossido di azoto, in posizione 0%.

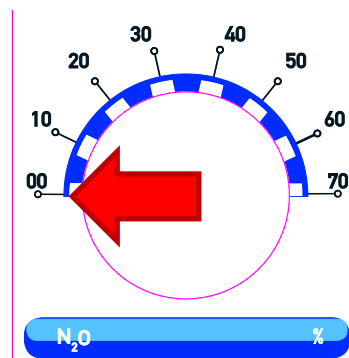

Aprire LENTAMENTE la valvola della bombola dell'ossigeno (ruotare in senso antiorario il rubinetto), verificare che la bombola del protossido di azoto sia chiusa (ruotare in senso orario il rubinetto).

Togliere il kit maschera dal MASTER FLUX PLUS sfilandolo dal tubo spiralato.

Inserire nel tubo spiralato nell'apposito raccordo (30).

Togliere la sacca (**F**) e inserire l'apposito tappo (**T**).

Collegare l'estremità del tubo per ossigeno terapia (31) al raccordo (30).

Collegare l'altra estremità del tubo per ossigenoterapia, alla borchia inferiore del pallone rianimatore (32) tramite l'apposito innesto.

Collegare la maschera (33), alla valvola del pallone rianimatore.

Ruotare la manopola **FLOW** per erogare Ossigeno al flusso desiderato, **CONTROLLARE I FLUSSI VISUALIZZATI.**

Il Flussimetro del PROTOSSIDO DI AZOTO = 0

Il Flussimetro dell'OSSIGENO = FLUSSO IMPOSTATO

Posizionare la maschera sul paziente.

Agire sulla sacca del pallone rianimatore in ottemperanza alle istruzioni per la rianimazione.

Terminato l'utilizzo del dispositivo è **IMPORTANTE** chiudere il rubinetto della bombola dell'Ossigeno (ruotando il senso orario).



Figura 19

FIGURA	POSIZIONE	Q.TA'	CODICE	DESCRIZIONE
11	29	1	1504/A OPZIONALE	TUBO SPIRALATO - CM88051
	30	1		RACCORDO – SMFA278
	31	1		TUBO OSSIGENO – CM84022
	32	1		PALLONE RIANIMAZIONE – 1025-2
	33	1		MASCHERA RIANIMAZIONE – CM84014

8**MANUTENZIONE****8.1****SOSTITUZIONE DELLE BOMBOLE**

Se la pressione delle bombole è molto bassa ~10÷20 bar, procedere alla sostituzione o alla ricarica delle bombole.

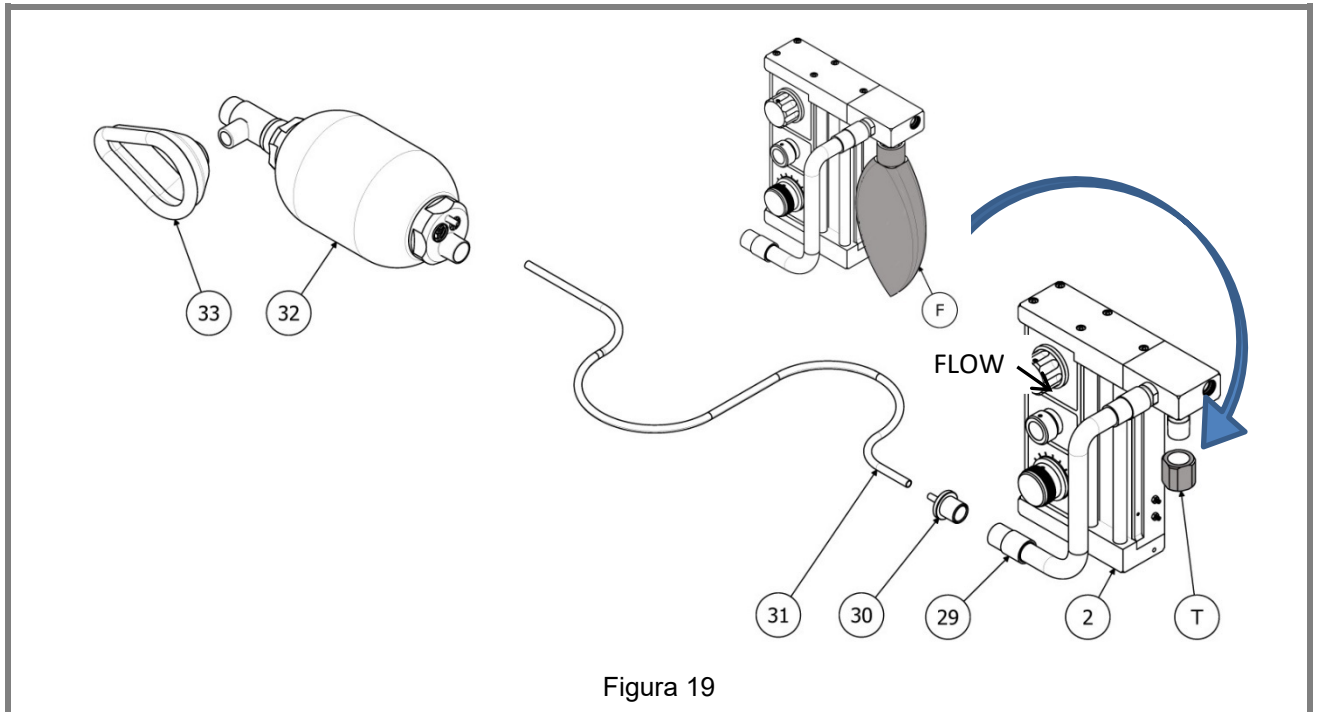

Si consiglia di sostituire la bombola di protossido di azoto ogni 2 bombole di ossigeno.

Chiudere lentamente le valvole (ruotare in SENSO ANTIORARIO).

Scaricare l'impianto aprendolo tramite la manopola "FLOW" e "% N₂O", richiudere l'impianto.

Smontare i riduttori di pressione, conservandoli in un luogo riparato e pulito (Vedi installazione).

La ricarica, il controllo e collaudo periodico delle bombole deve essere eseguito da ditte specializzate in conformità alle direttive vigenti nel paese di utilizzo.

8.2**PULIZIA**

NON utilizzare detergenti aggressivi

Pulire le superfici del dispositivo con un panno asciutto.

Prima e dopo l'utilizzo pulire, detergere o sterilizzare i particolari a contatto con il paziente o con il suo respiro.



Pulire con Detergente con effetto antistatico il Plaxiglass® di protezione dei flussimetri

Tabella per la pulizia dei componenti MASTER FLUX PLUS

FIG/POS	MATERIALE	CODICE	DESCRIZIONE	STERILIZZAZIONE A VAPORE	N°CICLI STERILIZZAZIONE
3 / F	NEOPRENE	3MEDN0002	SACCA ANESTESIA 3LT	NO	-



Per la pulizia della maschera (ricambi in silicone e guscio) fare riferimento al manuale d'uso di "Circuiti e maschere".



GLI ARTICOLI IN DOTAZIONE VARIANO IN BASE ALLA CONFIGURAZIONE DEL DISPOSITIVO



Prima di ogni utilizzo controllare l'integrità dei componenti



Nel caso il MASTER FLUX PLUS rimanga fermo per più di un mese, eseguire un controllo funzionamento.

Il dispositivo MASTER FLUX PLUS è munito di sicurezze che regolamentano il corretto controllo del dispositivo, tuttavia si consiglia di verificare periodicamente il funzionamento del dispositivo eseguendo i seguenti controlli ordinari.

8.2.1 Controllo di funzionamento: Verificare il funzionamento in accordo alle istruzioni descritte al paragrafo "7.1 Istruzioni per l'utilizzo".

8.2.2 Verifica dei galleggianti presenti all'interno dei flussimetri: devono ruotare su se stessi e muoversi liberamente entro il cono di misura, quando si regolano le portate. Assicurarsi inoltre che i valori regolati siano stabili.

8.2.3 Controllo pulsante FLUSH: premere e verificare che il galleggiante del flussimetro N₂O scenda a 0 (zero) mentre l'ossigeno abbia massima erogazione.

Rilasciare il pulsante O₂ FLUSH verificando che l'erogazione di O₂ venga interrotta.

8.2.4 Controllo del blocco dell'N₂O: Impostare una erogazione con concentrazione 50%, chiudere la bombola dell'ossigeno (simulando così la situazione di bombola terminata) e accertarsi che dopo alcuni secondi, vi sia il blocco completo dell'erogazione dell'N₂O.

8.2.5 Verifica delle perdite: Chiudere la manopola "FLOW" (A – figura 9). Aprire le valvole delle bombole di Ossigeno e Protossido e rilevare i valori indicati dai manometri. Chiudere le valvole delle bombole. Lasciare trascorre ~ 5 minuti e rilevare i nuovi valori indicati dai manometri. Se i valori coincidono il dispositivo non presenta perdite.



Utilizzare esclusivamente ricambi e accessori originali



RIDUTTORI DI PRESSIONE

SEGUIRE LE INDICAZIONI RIPORTATE SUI MANUALI DEI DISPOSITIVI.



MASCHERINE E CIRCUITO COMPLETO

SEGUIRE LE INDICAZIONI SUL MANUALE CIRCUITI E MASCHERE DEI DISPOSITIVI.

SITUAZIONI CHE SI POSSONO VERIFICARE DURANTE IL FUNZIONAMENTO:

Problemi	Possibili cause	Rimedio
Non eroga ossigeno	Bombola scarica	Caricare la bombola
	Riduttore di pressione non funzionante	Sostituire il riduttore
	Problemi interni alla scatola flussometrica	Controllo del dispositivo presso TECNO-GAZ
Non eroga protossido di azoto	Mancanza di ossigeno	Caricare la bombola
	Riduttore di pressione non funzionante	Sostituire il riduttore
Indicatore del protossido proiettato verso la parte superiore	Manovra errata	Azzerare la manopola 'FLOW' Ripristinare il funzionamento corretto
	Problema interno	Controllo del dispositivo presso TECNO-GAZ

L'assistenza tecnica deve essere richiesta al deposito che ha fatturato il dispositivo, oppure direttamente a:

TECNO-GAZ S.p.A.

Strada Cavalli 4, 43038, Sala Baganza, Parma, ITALIA.

www.tecnogaz.com

PHONE	+39 0521 8380
FAX	+39 0521 833391
@	Service1@tecnogaz.com

Sarà l'assistenza a valutare il rientro in sede o l'intervento di un tecnico e visionata la macchina a stilare un preventivo di spesa, che verrà inoltrato al cliente distributore che lo trasmetterà al cliente finale, per presa d'atto e sottoscrizione.

Dopo aver ricevuto il preventivo sottoscritto per accettazione, il dispositivo verrà messo in lavorazione e verrà spedito nei tempi indicati sul modulo del preventivo.

Per la spedizione del dispositivo:

- Utilizzare l'imballo originale, se questo non è più in Vostro possesso, utilizzare un imballo adeguato. La merce viaggia con rischio a carico del mittente.
- Spedire solo la scatola flussometrica e i riduttori di pressione, inseriti singolarmente in un celophan pulito.
I riduttori non devono essere contaminati (detergenti, alcool, oli ...) se l'assistenza non ritiene l'imballo idoneo, i riduttori verranno rottamati.
- Indicare per iscritto, ed inserire nell'imballo un documento ove si indichi con precisione l'anomalia riscontrata o il servizio di cui si intende beneficiare.
- Spedire sempre in porto franco, diversamente saranno addebitate le spese di trasporto sostenute.

Tutti gli imballi non originali che ci perverranno, verranno smaltiti.

La macchina verrà rispedita con imballo originale (il costo dell'imballo vi sarà addebitato) mediante spedizioniere del cliente.

TABLE OF CONTENTS

- 1. UTILISATION AND INTENDED USE**
- 2. SAFETY**
 - 2.1 SAFETY MARKING
 - 2.2 SAFETY DEVICES
 - 2.3 HANDLING
 - 2.3 DISPOSAL
- 3. TECHNICAL DATA**
- 4. UNPACKING**
- 5. COMPONENTS**
 - 5.1 COMPONENTS SUPPLIED LIST
 - 5.2 UNIT-MOUNTED COMPONENTS
 - 5.3 WALL-MOUNTED COMPONENTS
 - 5.4 USER INTERFACE
 - 5.5 MASKS
 - 5.6 MASKS MEASURES
 - 5.7 MASKS CIRCUIT
- 6. INSTALLATION**
 - 6.1 INSTALLATION OF UNIT-MOUNTED MASTER FLUX PLUS
 - 6.2 INSTALLATION OF WALL-MOUNTED MASTER FLUX PLUS
 - 6.3 CONNECTING CIRCUITS AND ACCESSORIES
 - 6.4 EVACUATION OF EXHALED GASES
 - 6.4.1 DIRECT CONNECTION TO THE OUTSIDE OF THE OFFICE
 - 6.4.2 CONNECTION TO A SURGICAL ASPIRATOR
- 7. OPERATION OF THE APPLIANCE**
 - 7.1 USER INTERFACE COMMANDS AND DEVICES
 - 7.2 INSTRUCTIONS FOR USE
 - 7.3 RESUSCITATION WITH MASTER FLUX PLUS
- 8. MAINTENANCE**
 - 8.1 CYLINDERS CHANGING
 - 8.2 CLEANING
 - 8.3 SCHEDULED MAINTENANCE
- 9. ALARMS**
- 10. PROCEDURES FOR AFTER SALE SERVICE**
- 11. SUPPLIED ACCESSORIES**

1

UTILISATION AND INTENDED USE**INTENDED USE**

MASTER FLUX PLUS is a device designed for conscious sedation or sedative analgesia. Conscious sedation consists in administering a mixture of nitrous oxide and oxygen to the patient.

USE

The concentrations of the administered mixture are:

O₂ ≥ 30%

N₂O ≤ 70%

It is administered through a nasal mask. The patient must inhales the mixture by breathing actively through his/her nose.

Conscious sedation is suitable for all patients of an orthodontic practice, both adults and children.

Conscious sedation allows the patients to undergo orthodontic procedures limiting the fear and anxiety that all patients experience when they enter an orthodontic office.

**IT IS NOT SUITABLE:**

- DURING PREGNANCY,
- FOR PATIENTS WITH DRUG ADDICTIONS
- FOR PATIENTS SERIOUS PULMONARY INFECTIONS
- INDIVIDUALS WITH SERIOUS MENTAL ILLNESS.



MASTER FLUX PLUS must only be administered by specifically trained medical staff.



Do not use this device to administer general anaesthesia or as a part of or in combination with a general anaesthesia system.



The sale of this device is limited by law to doctors and orthodontists only.

ATTENTION

Do not attempt to repair, modify or calibrate this device. Unauthorised repairs, modification or abuse of this device negatively affects its performance and invalidates the warranty.



Before each use make sure the gas supplies are connected correctly



The device administers drugs solely for conscious sedation



The contra-indications for the use of the drug are stated in the safety sheet and documents attached to the drug supply. If they are not provided in attachment, request it from the gas supplier.



Do not remove the label



Do not replace the supplied gearboxes with other ones not provided by the manufacture.

2

SAFETY

**Use of the PULSE OXIMETER must be routine during conscious sedation.
The meaning of the detected values:**



Saturation values O ₂	Hypoxia level
≥ 95%	No hypoxia
90-94%	Low-grade hypoxia
85-89%	Moderate hypoxia
84%	Serious hypoxia

2.1 Safety marking

The device complies with Directive 93/42 EEC as amended.
The conformity declaration is provided in attachment to the device.

2.2 Safety devices

The device is fitted with safety devices:

- If the oxygen (O₂) pressure drops, the delivery of nitrous oxide (N₂O) is automatically shut off.
- An incorporated mixing system regulates the N₂O so that there is always a minimum quantity of O₂ in the mixture of at least 30%.
- If the gas mixture flow is shut off, the patient will breathe air from the outside through a specific safety valve.
- If the flow changes direction, returning to the device, a one-way valve protects the patient from re-inhaling exhaled gases and from accumulations of carbon dioxide (CO₂).
- The flow setting knob controls the overall flow; it automatically regulates the flow of oxygen and nitrous oxide according to the set percentage.
- The 'FLUSH' button allows high flows of pure oxygen to be delivered.
- The maximum delivery of nitrous oxide (N₂O) is 70% of the total flow. The amount of oxygen (O₂) can never drop below 30%.

WARNINGS & USEFUL NOTIONS



DURING GAS ADMINISTRATION IT IS ESSENTIAL TO BE PRESENT AT ALL TIMES, TO KEEP THE OXYGEN AND NITROUS OXIDE GAS FLOWS UNDER CONTROL BY CHECKING THE FLOW VALUES DISPLAYED IN THE FLOW METERS AND THE FLOW CONTROL BOX.

2.3 Handling



Please only use the supplied handles to move the Master Flux Plus furniture unit.

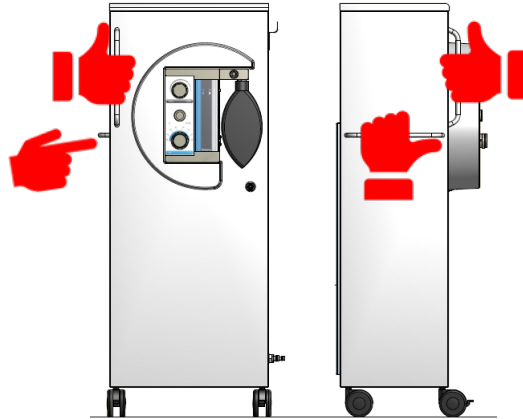

Figure 1

	<p>Do not push the furniture unit without using the appropriate handles.</p>
	<p>Do not sit on the furniture item or place any weights on it.</p>
	<p>Before moving the furniture unit please carefully put the panel and tubes back into the fixing system, trying not to stumble or break anything.</p>

2.4 Disposal

The disposal of the packaging, device and single components should take place in compliance with the regulations applicable to the treatment and elimination of potentially bio-contaminating waste in the country of use.

Do not dispose of the packaging materials as household waste.

The device does not contain electrical / electronic components and contains no battery.

3

TECHNICAL DATA

POWER SUPPLY

Power supply pressure	3.5 bar \cong 50 PSI (max 6 bar \cong 87 PSI)
Maximum flow rate	10 NL/min. (litres per minute)

WEIGHT UNIT-MOUNTED MASTER FLUX PLUS:

Weight without cylinders	42 Kg
Sustainable maximum weight, tanks compartment, wheels level	180 Kg
Sustainable maximum weight, upper tanks compartment	45 Kg

CYLINDERS FOR UNIT-MOUNTED MASTER FLUX PLUS:

Maximum height	950 mm
Maximum diameter	140 mm

WEIGHT WALL-MOUNTED MASTER FLUX PLUS:

Weight of the flowmeter box	6,3Kg
-----------------------------	-------

FLOW METER:

Repeatability	+/-10% flow indicated
---------------	-----------------------

Flow rate is then measured against the flat top edge of the float, reducing parallax errors.

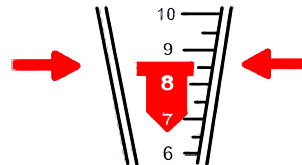

CONSUMPTION:

Below is an example of consumption, to be used as a theoretical reference

10 Lt MEDICAL OXYGEN CYLINDER
CHARGED AT A PRESSURE OF 200 Bar

AVAILABLE VOLUME	2000 gaseous Litres
------------------	---------------------

10 Lt NITROUS OXIDE CYLINDER
CHARGED WITH 7 Kg of LIQUID GAS

AVAILABLE VOLUME	4600 gaseous Litres
------------------	---------------------

BY SETTING:

DELIVERY	10 NLt/min
MIXTURE	50 %

AUTONOMY:

OXYGEN	400 min
NITROUS OXIDE	950 min



Taking into account the average gas consumption parameters, TECNO-GAZ advises replacing a nitrous oxide tank every 2 oxygen tanks.

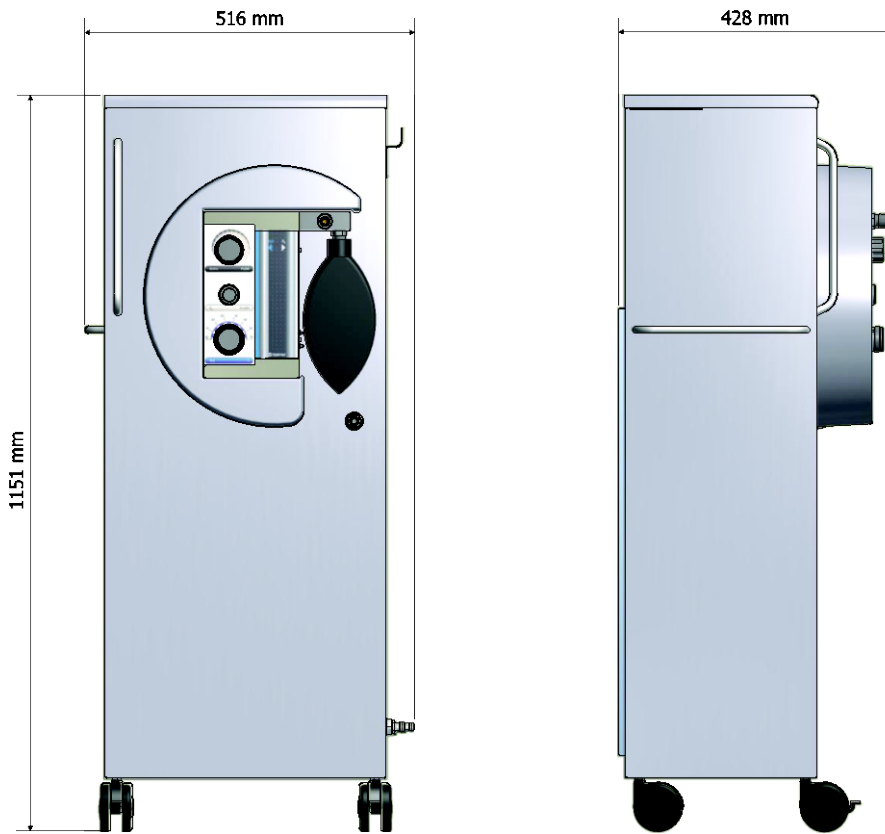

Figure A

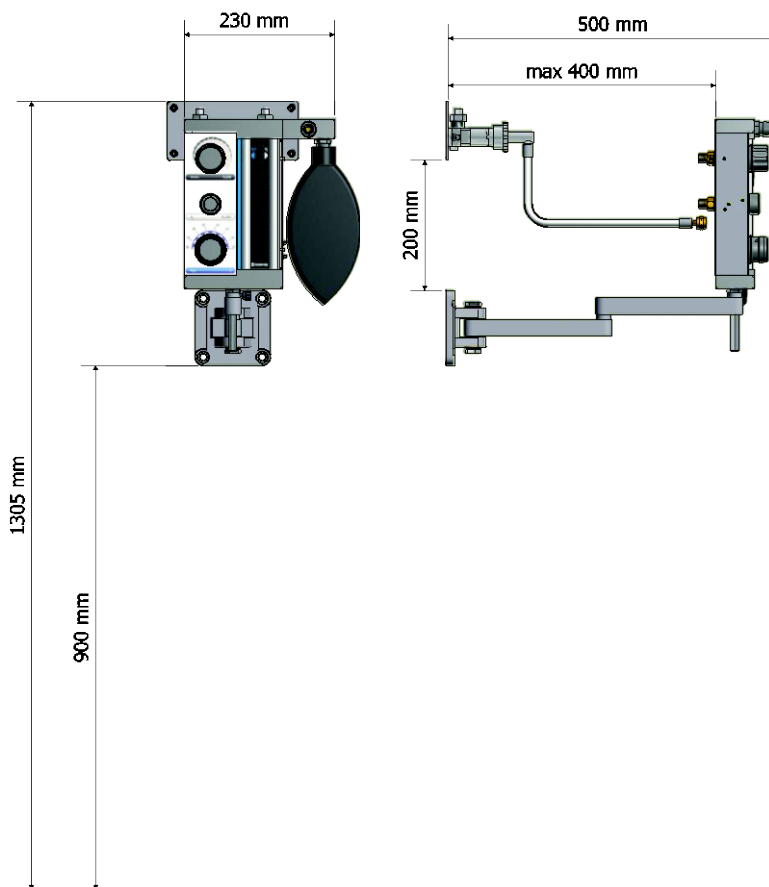

Figure B

04

UNPACKING



IT IS FORBIDDEN TO STACK MASTER FLUX PLUS UNITS



The packing shall not undergo any shock and shall be handled with care avoiding letting it roll or fall.



Do not use appliances with clear damages due to the transport.



Remove the packaging and check the appliance condition.



The packaging shall be stored for the whole warranty period.
The manufacturer does not accept returns deprived of their original packing.



The devices must be kept safe in a dry location and at a temperature between +5 / +40 °C.

05

DESCRIPTION OF COMPONENTS

5.1

Components supplied list

ARTICLE	16010ZMF wall-mounted Master Flux Plus with Reducers with AFNOR Oxygen and UNI Nitrous Oxide	1601ASD wall-mounted Master Flux Plus with Reducers with Oxygen and Nitrous Oxide DIN attachments	160IAS wall-mounted Master Flux Plus with Reducers with Oxygen and Nitrous Oxide UNI assemblies	MF009ZMF Master Flux Plus unit-mounted without gear reducer kit	MF006ZMF Master Flux Plus unit-mounted with Reducers with AFNOR Oxygen and UNI Nitrous Oxide	1600ASD Master Flux Plus unit-mounted with Reducers with Oxygen and Nitrous Oxide DIN	1600ASF Master Flux Plus unit-mounted with Reducers with Oxygen and Nitrous Oxide AFNOR	1600AS Master Flux Plus unit-mounted with Reducers with Oxygen and Nitrous Oxide UNI
UNIT-MOUNTED	SMFA301	SMFA301	SMFA301	2ZMFA0020	2ZMFA0020	2ZMFA0020	2ZMFA0020	2ZFMA0020
MASTER KIT	22ZMFA0065	22ZMFA0063	22ZMFA0062	2ZMFA0057	2ZMFA0059	22ZMFA0058	22ZMFA0061	22MFA0060
REDUCER N ₂ O	SMFA360	SMFA360	SMFA360		MF011ZMF	MF011ZMF	MK005ZMF	MF011ZMF
REDUCER O ₂	SMFA361	SMFA358	MF003ZMF		1513A4F	1513A4D	1513A4F	1513A4
MASKS								

MF820ZMF Master Flux circuit

MF824ZMF Master Flux Plus suction circuit (new)

MF835ZMF Intelliflux 1 complete mask Master Flux plus 0-4 years

MF836ZMF Intelliflux 2 complete mask Master Flux plus 4-10 years

MF837ZMF Intelliflux 3 complete mask Master Flux plus > 10 years

5.2

Unit-mounted COMPONENTS

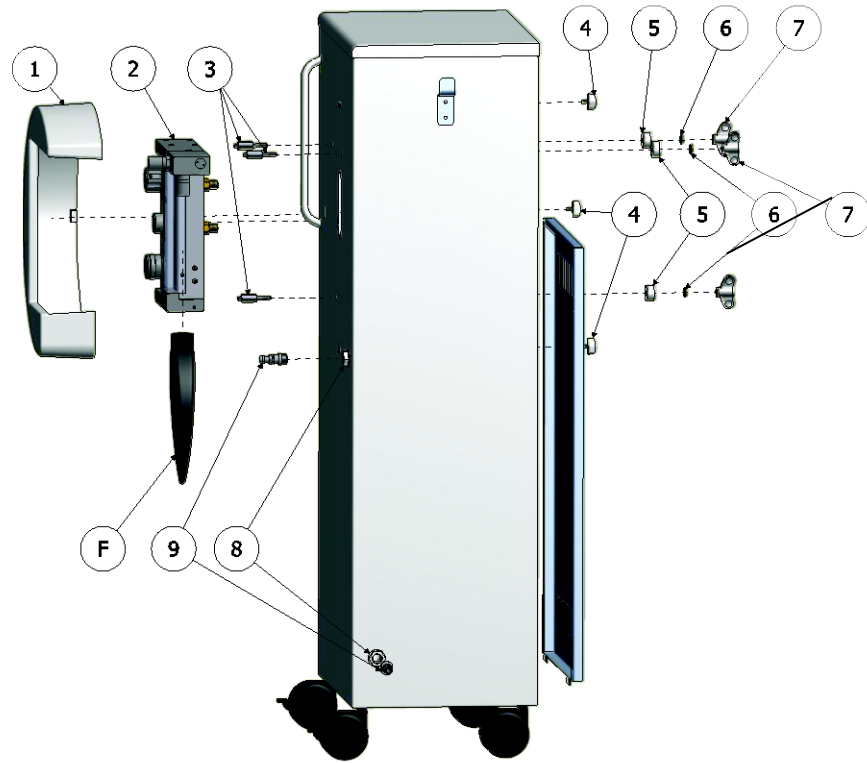

Figure 2

FIGURE	POSITION	Q.TY	CODE	DESCRIPTION
3	1	1	SMFA144	PLASTIC COVERING
	2	1	SMFA506	FLOW MEASUREMENT BOX
	3	3	SMFA223	SPACER
	4	3	CM25021	M5 FLAP SCREW
	5	3	3MECQ0010	SPACER
	6	3	CM20015	WASHER
	7	3	CM25019	M6 FLAP NUT
	9	2	SMFA237	GAS ELIMINATION HOSE FITTING

5.3

Wall-mounted COMPONENTS

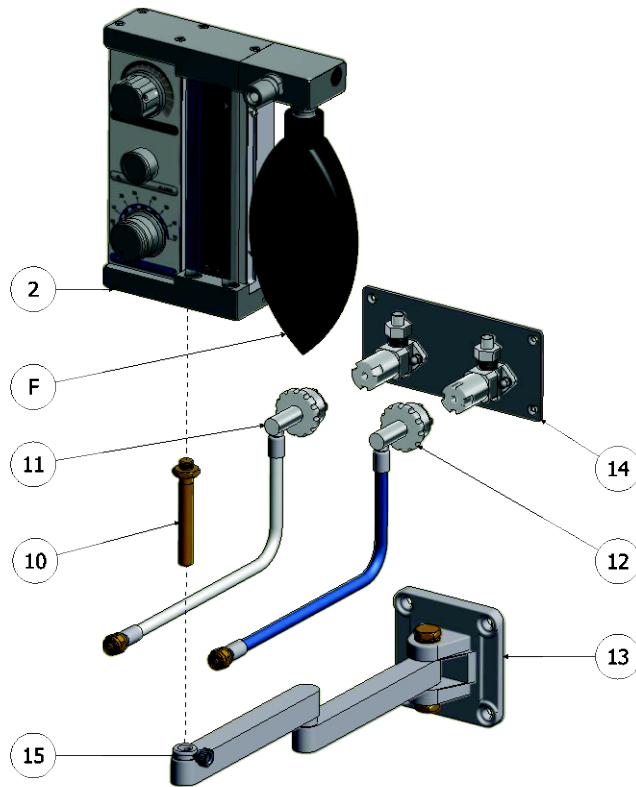

Figure 3-4

WALL MOUNTED (Figures 3-4)

FIGURE	POSITION	Q.TY	CODE	DESCRIPTION
4	10	1	SMFA313	PIN
	11	1	SMFA364	O ₂ TUBE
	12	1	SMFA365	N ₂ O TUBE
	13	1	SMFA301	WALL-MOUNTED SUPPORT
	14	1	SMFA501	WALL PLATE
	15	1	CM30011	PIN SECURING KNOB

5.4

USER INTERFACE

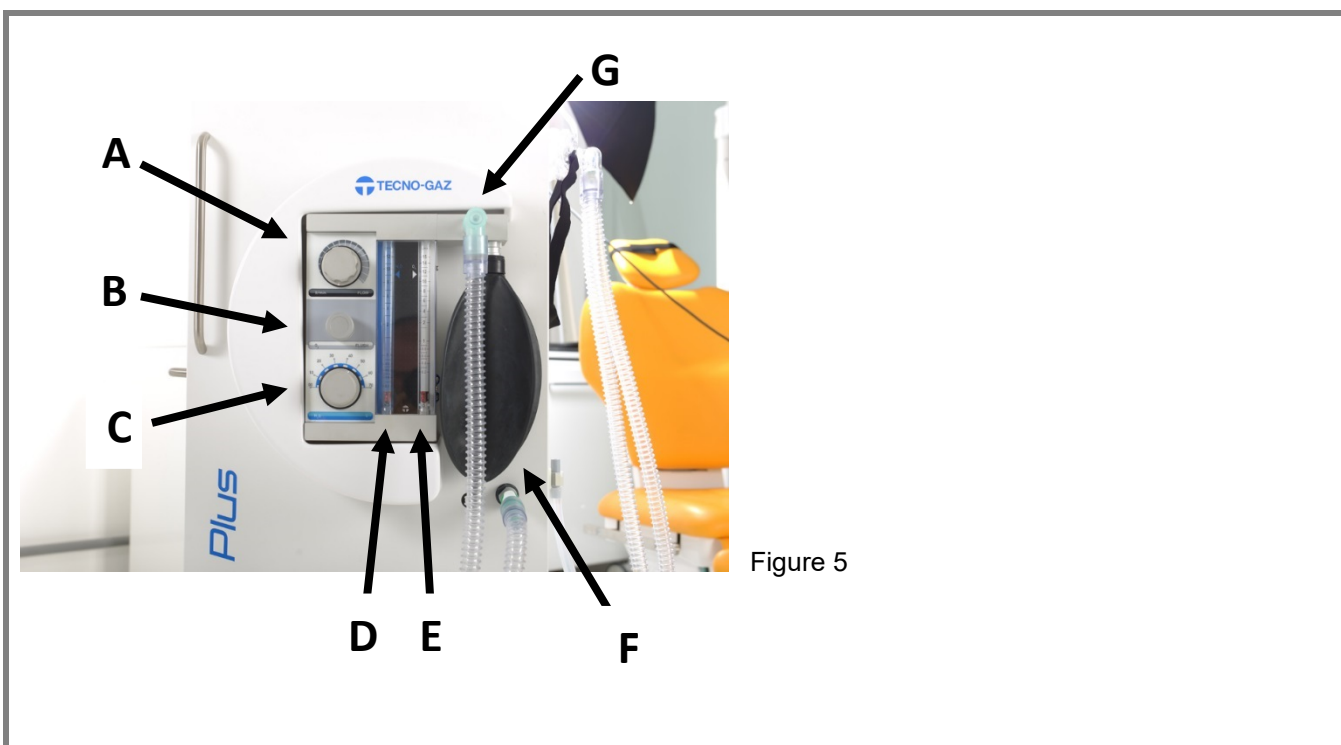

Figure 5

A	FLOW knob
B	FLUSH button
C	% N ₂ O knob
D	N ₂ O flowmeter
E	O ₂ flowmeter
F	Rubber bag
G	Mask connection nozzle

5.5

MASKS

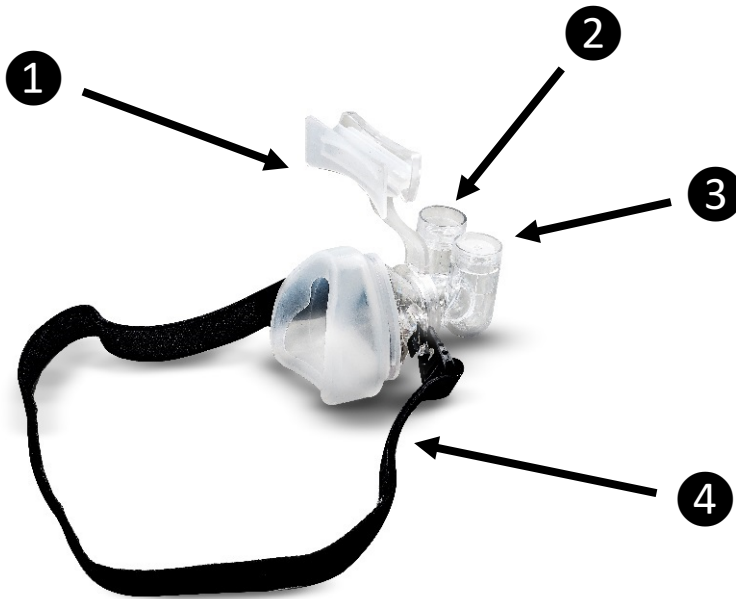

Figure 6

①	Support area for the patient's forehead
②	Gas inlet with non-return valve
③	Gas outlet with non-return valve and PC printed arrow to indicate the flow direction
④	Velcro elastic band with plastic hooks

5.6

MASKS MEASURES

MF835ZMF MASK 1 0-4 years	MF836ZMF MASK 2 4-10 years	MF837ZMF MASK 3 >10 years	MF838ZMF MASK 4

Figura 7

5.7

MASKS CIRCUIT



Figure 8

COMPLETE CIRCUIT OF MASKS

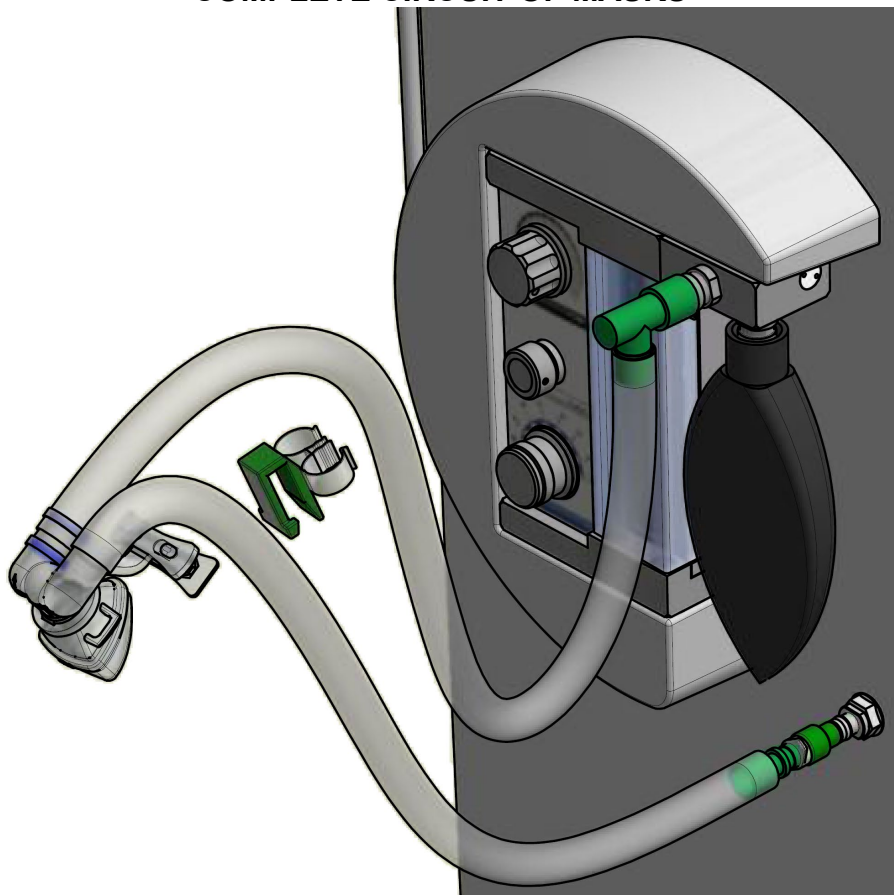

Figure 9



For parts of individual components, refer to the "Circuits and Masks" user manual.

06

INSTALLATION



Remove the packaging and check the conditions of the equipment.
Do not use equipment that presents evident damage due to transportation.

6.1 Installation of unit-mounted MASTER FLUX PLUS**FLOWMETER BOX INSTALLATION** (Figure 2)

see enclosed Quick Guide 0ZMFI0007

Screw the 3 steel spacers (3) onto the flowmeter box (2).

Remove the protections from the flowmeter box supply nipples.

Install the flowmeter box on the unit by inserting the steel spacers (3) into the relative holes on the unit, securing them to the unit using 3 plastic spacers (5), 3 washers (6) and the three thumb nuts (7) supplied.

FRONT COVER INSTALLATION (Figura 2 Pos 1)

see enclosed Quick Guide 0ZMFI0007

Position the plastic cover near the three holes on the unit.

Attach the plastic cover by screwing on the three thumb screws (4) supplied.

EXHAUST NOZZLE INSTALLATION (Figura 2 Pos 9)

see enclosed Quick Guide 0ZMFI0007

If you are using the exhaled gas exhaust tube, screw the supplied nozzles onto the plastic fittings.

CYLINDER INSTALLATION (NOT SUPPLIED) (Figure 10)

Attach the reducers to the cylinders (see instruction manual for reducers).

For 5 lit cylinders install the shelf and attach it using the relative shelf stops.

For 10 and 14 lit cylinders position the shelf on the bottom of the unit.

The reducer pressure gauges (M) must be placed in such a way that they are visible to the operator.

Lock the cylinders to the piece of furniture using the special Velcro strap supplied.

Secure the cylinders to the unit using the velcro strap supplied.

Screw the O₂ reducer (R1) tube end nut onto the flowmeter box supply nipple (I) (RIGHT THREADING).

Screw the N₂O reducer (R2) tube end nut onto the flowmeter box supply nipple (H) (LEFT THREADING).

Close the rear door with the two magnets located on the top of it.



Figura 10

FIGURE	POSITION	Q.TY	CODE	DESCRIPTION
6	R1	1	1513A4	O ₂ GEARBOX (ITA)
	R2	1	MF011ZMF	N ₂ O GEARBOX (ITA)
	L	1		VALVE
	M	1		PRESSURE GAUGE

6.2 Installation of wall-mounted MASTER FLUX PLUS

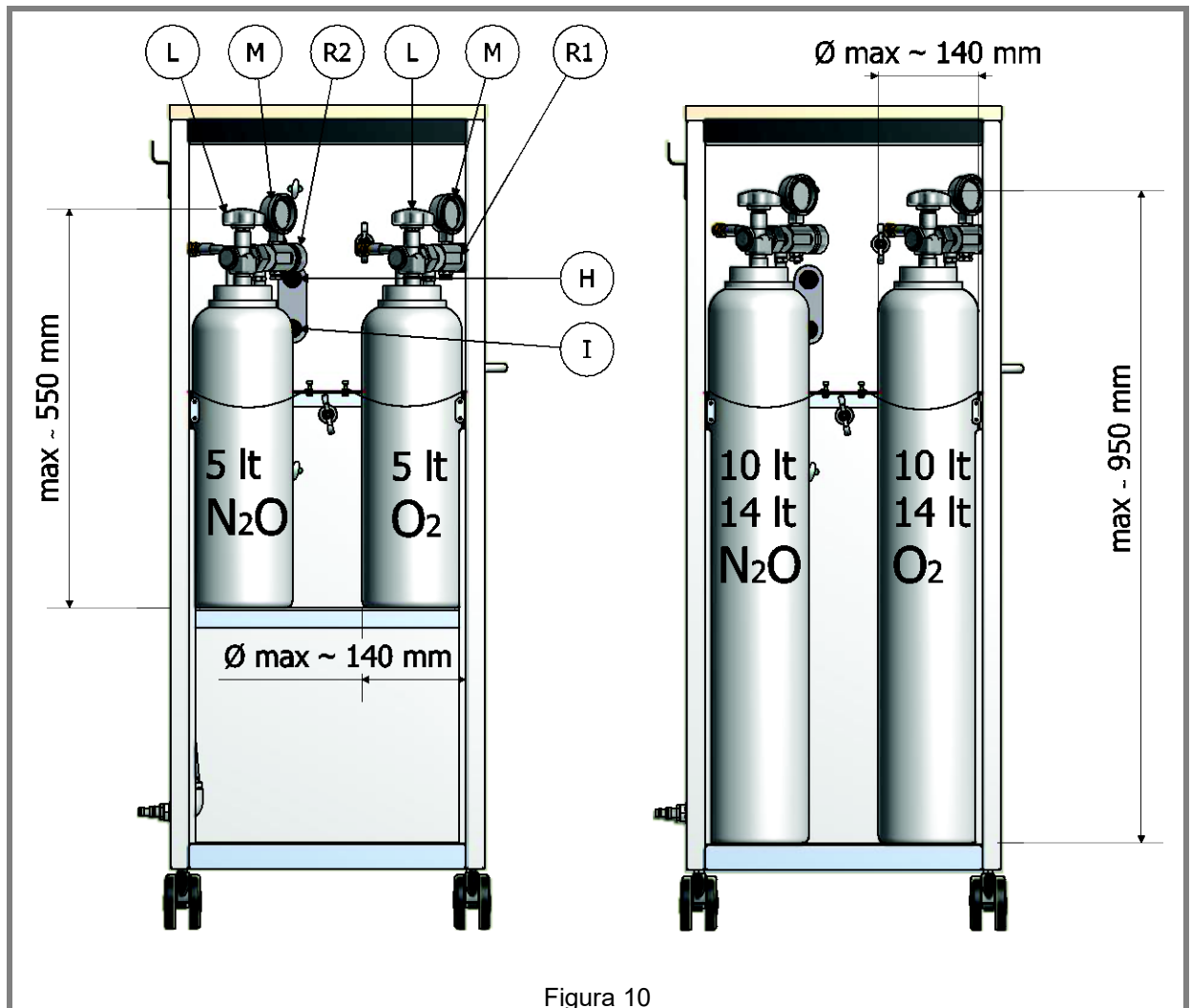
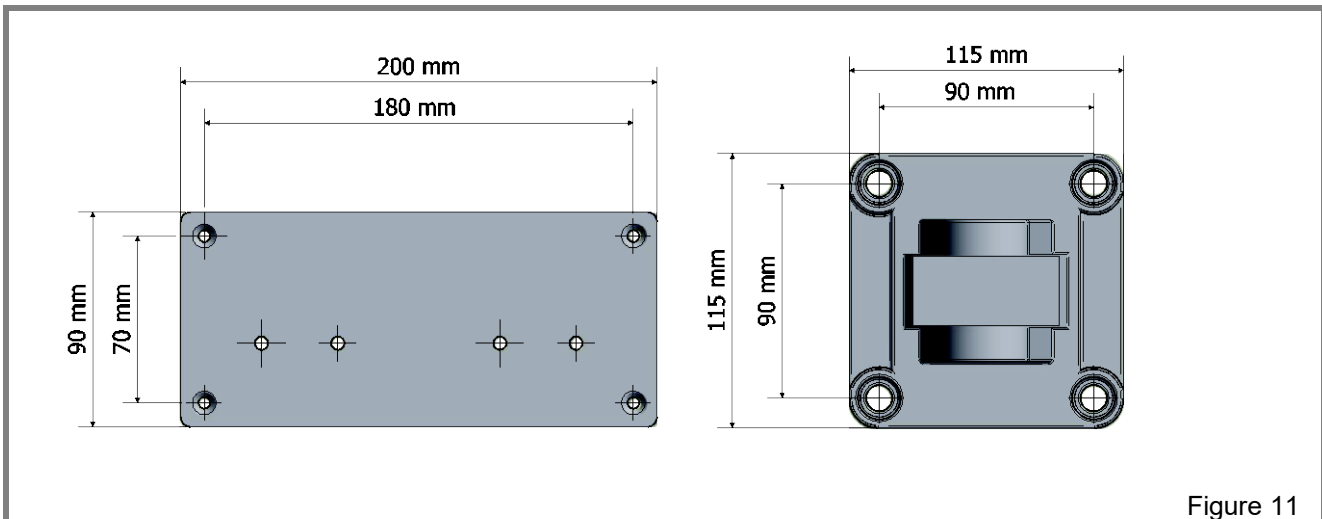

Figure 11



Figure 12

(FIGURE 5, 10)

Attach the MASTER FLUX PLUS SUPPORT to the wall (13) using 4 Ø14 mm M8 wall dowels.

Attach the MASTER FLUX PLUS PLATE to the wall (14) using 4 Ø 8(mm) wall dowels.

Screw the pin (10) onto the base of the flowmeter box.

Slot the pin into the end of the support (15).

Lock the pin to the support using the relative threaded knob.

Screw the nut on the N2O tube onto the N2O flowmeter box (H)supply nipple (RIGHT threading).

Connect the nut on the O2 tube to the O2 flowmeter box supply nipple (LEFT threading).

Connect the free ends of the tubes to the wall outlets (press the couplings and turn to lock the coupling to the outlet).

NOTES ON THE CENTRALISED SYSTEM

Installation must be carried out by specialised technicians. The centralised system must be set up in compliance with regulations in force European Directive 93/42/EC

Connect the wall outlet to the equipotential point on the electrical system, with the supplied loop connectors.

The supplied reducers must be connected to the cylinders of the centralised system.

The outlet of the **N₂O** reducer includes a flexible tube that is connected on one end to a male fitting with **1/4" G** threading for connection to the system.

The outlet of the **O₂** reducer includes a flexible tube that is connected on one end to a male fitting with **1/8" G** threading for connection to the system.

The fastening plate is not supplied.

6.3 Connecting circuits and accessories:

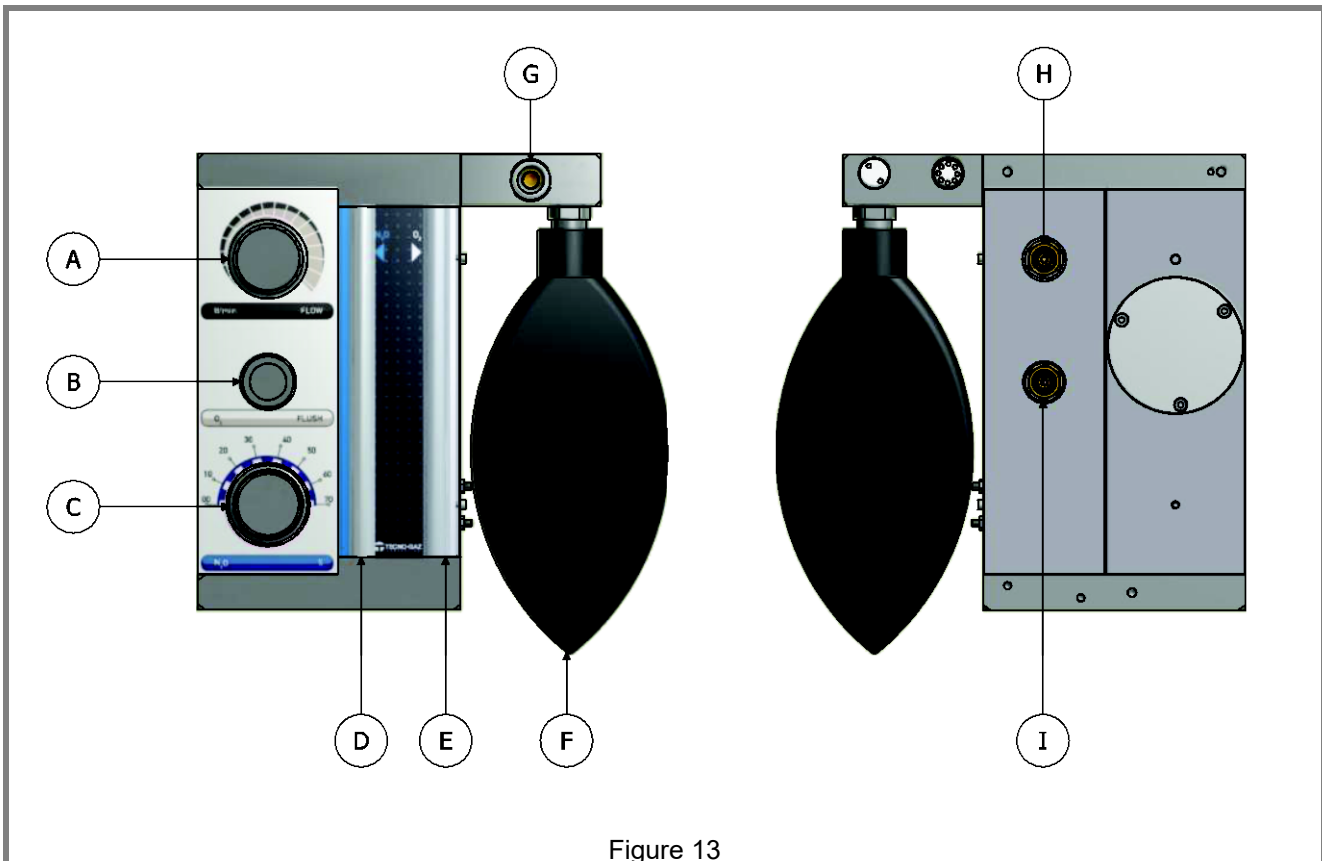

Figure 13

FIGURE	POSITION	Q.TY	CODE	DESCRIPTION
8	A	1		'FLOW' KNOB
	B	1		'FLUSH' BUTTON
	C	1		'% N2O' KNOB
	D	1		N2O FLOW RATE GAUGE
	E	1		O2 FLOW RATE GAUGE
	F	1	3MEDN0002	RESERVOIR BAG
	G	1		MASK CONNECTION NOZZLE
	H	1		NIPPLE N2O
	I	1		NIPPLE O2

Connect the Rubber bag (F) to the flowmeter box by pressing it onto the relative nozzle.

The mask kits are connected to the device by the nozzle (G).

The gas exhaust tube will be connected in different ways, based on the type of gas evacuation system that is being used. (see 6.4 - EVACUATION OF EXHALED GASES).

6.4 Evacuation of exhaled gases:

To safeguard the work environment and the staff, the exhaled gases must be conveyed outside of the work environment.

Two systems can be used to discharge the gases externally:

- Direct connection to the outside of the office
- Connection to a surgical aspirator.

It is important to evaluate:

- Whether the aspirator is suitable for the evacuation of the gases (**N₂O and O₂**)
- The aspirator exhaust must be outdoors and ventilated.

Make sure it is compliant with regulations in force in the country of use.

6.4.1 Direct connection to the outside of the office

UNIT-MOUNTED MASTER FLUX PLUS

Screw the hoses (**Figure 2 Pos 8/9**) to the unit.

Remove the supplied valve.

Connect the mask circuit gas exhaust tube to the nozzle (**Figure 15**).

Connect the gas evacuation spiral tube (**Figure 14**) to the nozzle on the unit.

Connect the end of the spiral tube to the outside and make sure there is a final filter (Figure 14 Pos 34).

WALL-MOUNTED MASTER FLUX PLUS

Connect the gas exhaust tube to the mask circuit to the nozzle (**Figure 14 Pos 36**).

Connect the end of the spiral tube to the outside and make sure there is a final filter (**Figure 14 Pos 34**).

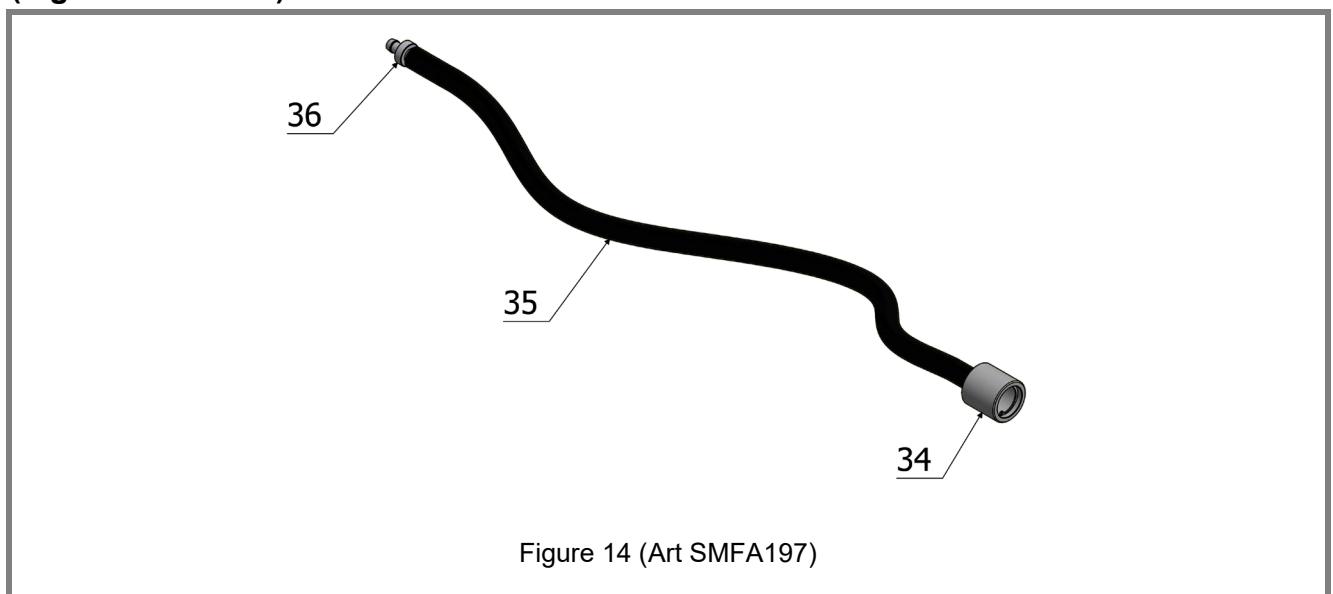

Figure 14 (Art SMFA197)

FIGURE	POSITION	Q.TY	CODE	DESCRIPTION
9	34	1	SMFA197	FILTER - SMFA260
	35	1		TUBE – SMFA199
	36	1		FITTING – SMFA257



Figure 15

6.4.2 CONNECTION TO A SURGICAL ASPIRATOR

UNIT-MOUNTED MASTER FLUX PLUS

Screw the hoses (Figure 2 Pos 8/9) to the unit-mounted.

Connect the mask circuit gas exhaust tube to the supplied fitting (**Figura 17**).

Connect the suction circuit (Figure 16) to the hose fitting.

Connect the fitting to the surgical aspirator tube (Ø11 mm).

WALL-MOUNTED MASTER FLUX PLUS

Remove the tube (Figure 16 Pos 43).

Connect the tube, gas exhaust of the mask circuit, to the valve (Figure 16 Pos 44).

Connect the fitting to the surgical aspirator tube (Ø11).

VALVE ADJUSTMENT

Turn the perforated ring nut on the valve (**Figura 16 Pos 44**) until the holes close.

Start gas delivery by setting ~10 l/min.

Start the surgical aspirator by setting the minimum aspiration value.

Observe the bar (**Figura 13 Pos F**).

Turn the perforated ring nut on the valve gradually opening the holes until the bag reaches its ideal condition of **“HALF FULL HALF EMPTY”**

ATTENTION

By changing the flow delivery it may be necessary to adjust the correct aspiration flows of the exhaled gases.

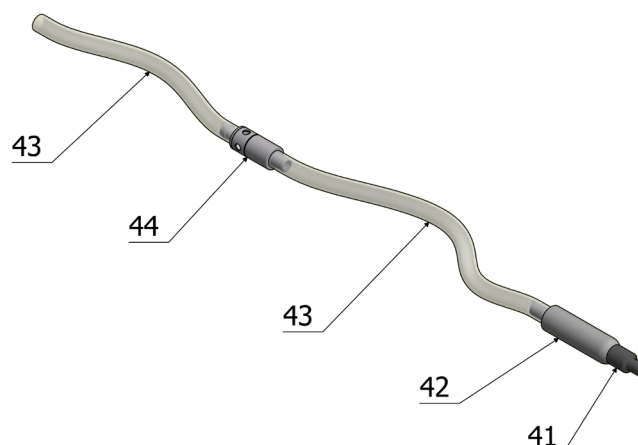

Figure 16 (Art MF824ZMF)

FIGURE	POSITION	Q.TY	DESCRIPTION
9A	41	1	REDUCTION
	42	1	TERMINAL PART
	43	2	PIPES
	44	1	VALVE



Figure 17

7

OPERATION OF THE APPLIANCE

7.1 USER INTERFACE COMMANDS AND DEVICES



Figura 18

CONTROL KEYS (FIGURE 10)

A	FLOW KNOB – DELIVERED FLOW REGULATION
B	EMERGENCY FLUSH BUTTON – ONLY OXYGEN DELIVERY
C	NITROUS OXIDE % REGULATION KNOB



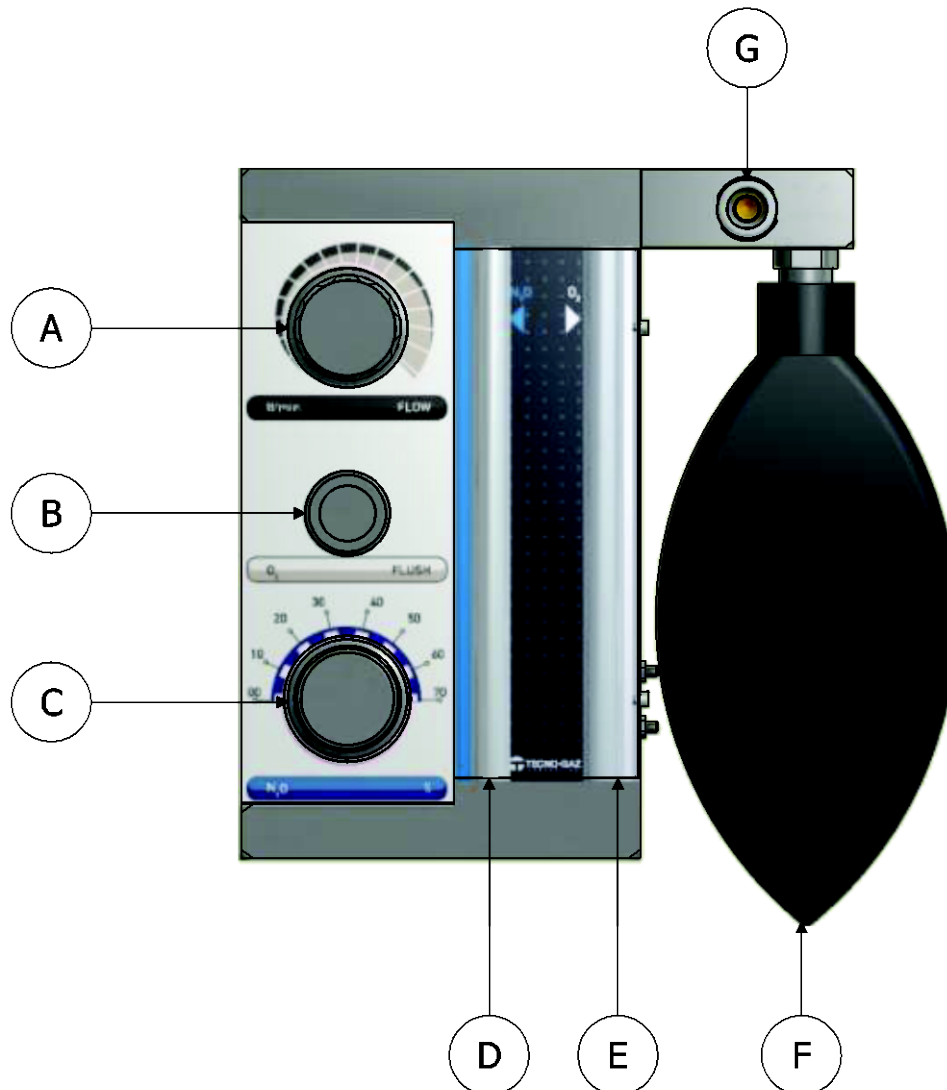



CONTROL ELEMENTS

E	PURE OXYGEN FLOW
D	PURE NITROUS OXIDE FLOW
F	BALLOON (CHECK – ADEQUATE FLOW FOR THE PATIENT)



7.1 Instructions for use

Before using the unit-mounted MASTER FLUX PLUS version, lock the wheels that have brakes on them by pressing the tabs downwards.

If it becomes necessary to move the appliance unit (e.g. from one room to another), please unblock the wheels and push the device gently using the handles (see Paragraph 2.3)

	Avoid shocks and sudden movements that could cause accidental falls.
	Move and position the MASTER FLUX PLUS only on non-inclined and smooth surfaces.
	Make sure the cylinders are stable and secured correctly.
	Close the cylinders before moving the device.
	Do not use the handles to lift the device.
	Do not move the device using the handles.
	Do not expose the controls to involuntary knocks.

When using MASTER FLUX PLUS in its wall-mounted version, it is possible to move and position the flowmeter box as required by gripping the relative handle (Fig 4 Pos. 10).

	DO NOT LEAN ON AND DO NOT REST OBJECTS ON THE FLOWMETER BOX (BOTH WALL AND UNIT-MOUNTED VERSIONS). DO NOT FORCE THE ARM OF THE WALL-MOUNTED VERSION.
	SLOWLY OPEN THE VALVES ON THE O₂ AND N₂O CYLINDERS TURN THE VALVES COUNTER-CLOCKWISE (FIGURA 10 POS L).

Read the pressure on the pressure reducer pressure gauges, (see TECHNICAL DATA) to estimate the autonomy of the oxygen cylinder.

Please make sure that the balloon and tubes are inserted well into their fittings.

Choose the most suitable mask for the patient.



Place the mask on the patient fitting it on well around his/her nose.

Secure the mask to the loop on the back of the head rest of the dental chair.

Make sure that the tubes for the mask circuit do not get bent or choked.

The operator must be stationed in such a way that he/she can visually control:

- **THE RUBBER BAG** (Fig. 18 Pos. F)
- **THE FLOW METERS** (Fig. 18 Pos. D, E)

	During the procedure constantly check the flows displayed on the flow meters (Figure 13 Pos D, E).
	Before leaving the patient, even briefly, shut off sedation.

Make sure that the %N₂O knob (Fig.18 Pos C) index displays 0.

Using the FLOW knob (Fig.18 Pos A) administer a flow of 3 Lt/min of oxygen for 30 seconds.

INSTRUCT THE PATIENT TO BREATHE IN AND OUT FROM THE NOSE.

Use the FLOW knob (Pos A) to adjust the flow.

Gradually adjust the flow, check the status of the bag (Fig. 18 Pos F) which must take on a shape that we will define as **half full half empty**.

Make the patient breathe for at least one minute before **evaluating the flow**.

Once the ideal flow and the pulmonary capacity of the patient have been determined, adjust the gas elimination valve as explained in paragraph 6.4 'Evacuation of exhaled gases'.

It is possible to change the percentage of nitrous oxide using the % knob (Figure 18 Pos C).

The flow meters display the amount of Nitrous oxide and Oxygen that is delivered in litres/min.

The sum of the two flows is the amount initially set based on the patient's respiratory capacity.



The instructions below are examples of administration. Every user should set the flow and percent according to the patient subject to medicine administration.

PROCEDURE SPECIFICATIONS FOR CHILDREN:	PROCEDURE SPECIFICATIONS FOR ADULTS:
<p>The flow for CHILDREN is approximately 4-5 Lt/min.</p> <ul style="list-style-type: none"> - Turn the 'FLOW' knob clockwise to set the flow at 4/5 l/min and instruct the patient to breathe for ~1 minute. - Check the flow setting on the O₂ flow column (Figure 18, Pos E). - The bag must be half full half empty. 	<p>The flow for ADULTS is approximately 6-8 Lt/min.</p> <ul style="list-style-type: none"> - Turn the 'FLOW' knob clockwise to set the flow at 6-8 l/min and instruct the patient to breathe for ~1 minute. - Check the flow setting on the O₂ flow column (Figura 18, Pos E). - The bag must be half full half empty.

Using the % N₂O knob (Figure 18 Pos C) administer nitrous oxide, set it at **20%**, wait a few minutes and see how the patient reacts.

If the patient is not sedated gradually increase the percentage (ex 30%).

THE PERCENTAGE OF NITROUS OXIDE ADMINISTERED TO THE PATIENT MUST BE: THE LOWEST POSSIBLE LEVEL TO OBTAIN GOOD SEDATION (BASE LINE).

Once the patient's BASE LINE has been established, note down the FLOW value and the %N₂O on his/her medical record, this data will be useful for future procedures.



THE GAS MIXTURE THAT IS ADMINISTERED TO THE PATIENT:
MUST NOT EXCEED 70% NITROUS OXIDE
MUST NOT BE LOWER THAN 30% OXYGEN



If the patient reports symptoms of discomfort (nausea, dizziness, head ache) immediately stop administration.
The “FLUSH” button (Fig. 13 Pos. B) is located on the device.
By pressing this button the bag will fill with oxygen.
By pressing the bag we will administer the patient with elevated quantities of pure oxygen.

END OF THERAPY

The treatment will end when the orthodontist has finished the procedure on the patient.

To end treatment:

- Shut off the NITROUS OXIDE supply by turning (counter-clockwise) the %N₂O knob (C – figure 18) to the end stop (0%).
- Administer (as at the beginning of treatment) a flow of 3 Lt/min of oxygen for 2 minutes
- Shut off the OXYGEN supply by turning (counter-clockwise) the FLOW knob (A – figure 18) to the end stop.
- Loosen the loop that secures the tube and take the mask off of the patient.

Before signing the patient out keep him/her under observation (waiting room) for ~5÷10 minutes.

The doctor may deem it necessary to increase the observation period.

TANKS CLOSURE



Once the doctor has finished using the device it is **IMPORTANT** to close the cylinders.



Close the valve on the Nitrous oxide cylinder (N₂O), (turning it clockwise).



Close the valve on the Oxygen cylinder (O₂), (turning it clockwise).

TANKS STORAGE



At the end of the day, store the cylinders in a deposit in compliance with the laws in force.

7.3 RESUSCITATION WITH MASTER FLUX PLUS

*(KIT Art. 1504/A Not included – see figure 19)



RESUSCITATION procedures WITH MASTER FLUX PLUS must be carried out with the %N₂O knob that regulates the percentage of nitrous oxide in position 0%.

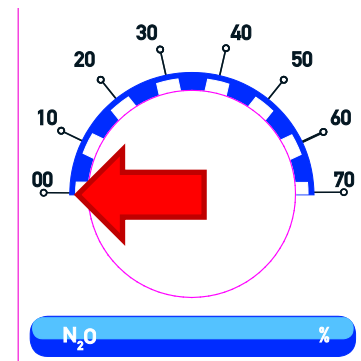

SLOWLY open the oxygen cylinder valve (turn the valve counter-clockwise); make sure that the nitrous oxide cylinder is closed (turn the valve clockwise).

Take the MASTER FLUX PLUS mask kit off by sliding it off of the spiral tube.

Insert the relative fitting (30) into the spiral tube.

Remove the bag (**F**) and put the cap (**T**).

Connect the end of the oxygen treatment tube (31) to the fitting (30).

Connect the other end of the oxygen treatment tube to the bottom stud of the resuscitation bag (32) through the relative coupling.

Connect the mask (33), to the valve on the resuscitation bag.

Turn the **FLOW** knob to deliver Oxygen at the required flow rate, CHECK THE FLOWS DISPLAYED ON THE FLOW COLUMNS.

The nitrous oxide flow meter =0

The oxygen flow meter = SET FLOW

Place the mask on the patient.

Act on the resuscitation bag in accordance with the resuscitation instructions.

Once use of the device is finished it is **IMPORTANT** to close the valve on the Oxygen cylinder (by turning it clockwise).

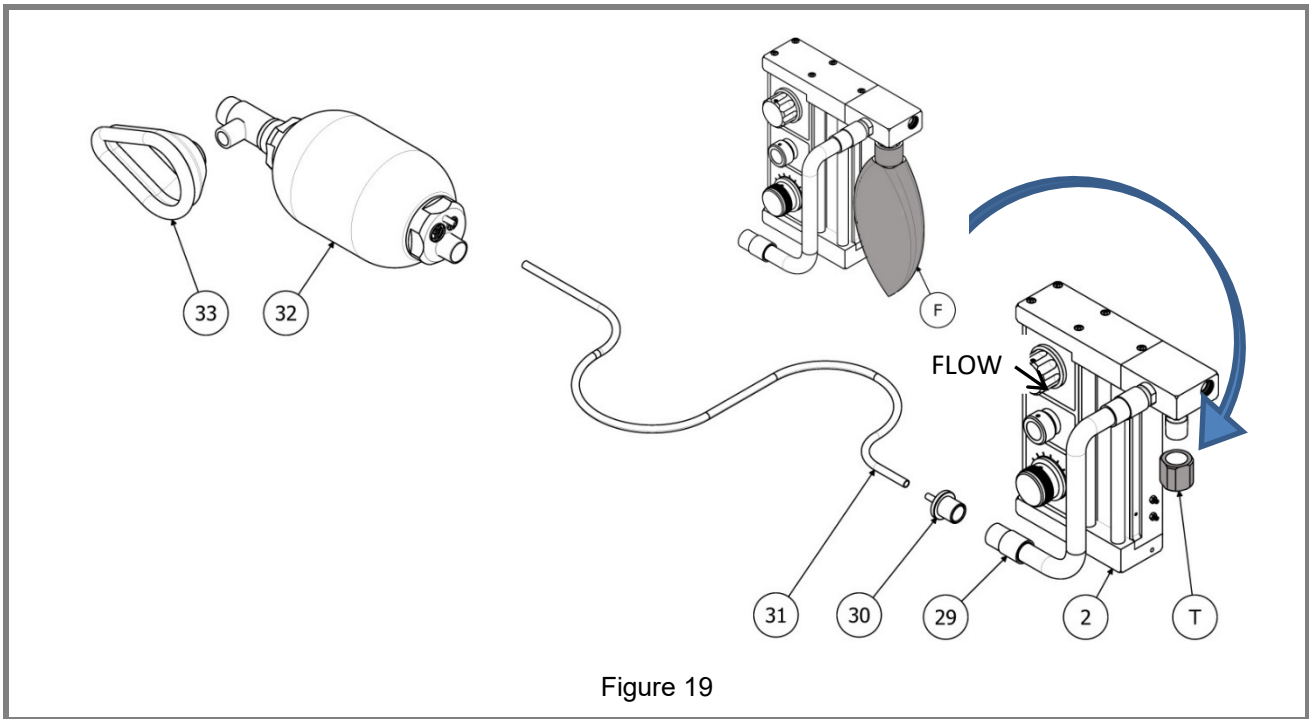

Figure 19

FIGURE	POSITION	Q.TY	CODE	DESCRIPTION
11	29	1	1504/A OPTIONAL	SPIRAL TUBE - CM88051
	30	1		FITTING – SMFA278
	31	1		OXYGEN TUBE – CM84022
	32	1		RESUSCITATION BAG – 1025-2
	33	1		RESUSCITATION MASK – CM84014

8 MAINTENANCE

8.1 CYLINDERS CHANGING

If cylinder pressure is very low ~10÷20 bar, proceed with changing or re-charging the cylinders.

 **We recommend replacing the nitrous oxide bottle every 2 oxygen tanks.**

Slowly close the valves (turn counter-clockwise).

Discharge the system by opening it from the “FLOW” and ‘%’ knob, then close it back up.

Take the pressure reducers out, keeping them in a covered and clean location. (See installation)

Re-charging, checking and periodic inspection of the cylinders must be carried out by specialised companies in compliance with regulations in force in the country of use.

8.2 CLEANING

 **Use detergents that are not aggressive to plastic**

Clean the surfaces of the device with a dry cloth.

Before and after use clean, wipe or sterilise the parts that come into contact with the patient or his/her breath.

 Clean the protection Plaxiglass® of the flow meters with an antistatic detergent

MASTER FLUX PLUS components cleaning table

FIG/POS	MATERIAL	CODE	DESCRIPTION	STEAM STERILISATION	NUMBER OF SERIALIZATION CYCLES
3 / F	NEOPRENE	3MEDN0002	RESERVOIR BAG 3LT	NO	-

 For cleaning the mask (silicone parts and shell) refer to the "Circuits and Masks" user manual.

 **THE SUPPLIED ITEMS VARY ON THE BASIS OF THE DEVICE CONFIGURATION**

8.3 SCHEDULED MAINTENANCE



Check the integrity of the components before each use



If MASTER FLUX PLUS has not been used for over a month make before an operational check.

MASTER FLUX PLUS is complete with security parts that are regulating the correct check of the device. Anyhow we recommend to check the functioning of the device doing the periodical standard tests.

8.2.1 - Function test: check that the device is working properly accordingly the instructions listed in par. 7.1 'Instruction for use'

8.2.2 - Check the floating balls in the flow meters; they must be able to rotate on themselves and move free in the measuring cone when regulating the flow. Be also sure that the set values are stable.

8.2.3 - Check the button FLUSH: press it and check that the N₂O floating ball is going to 0 (zero), oxygen on the other hand must reach max providing level. Leave o₂ FLUSH button: the O₂ supply must be interrupted.

8.2.4 - Check the hold of N₂O supply. Choose gas supply at 50% concentration. Close the bottle as if the bottle would be empty. Check that after some seconds the N₂O supply is completely stopped.

8.2.5 - Check for leaks: Close the "FLOW" knob . Open the valves on the Oxygen and Nitrous oxide cylinders and read the values provided by the pressure gauges. Close the cylinder valves. Wait ~ 5 minutes and read the new values displayed on the pressure gauges. If the values are the same, the device does not have any leaks.



Use only original spare parts and accessories



PRESSURE REDUCERS

FOLLOW THE INSTRUCTIONS CONTAINED IN THE DEVICE MANUALS.



FULL-CIRCUIT PANELS

FOLLOW THE INSTRUCTIONS CONTAINED IN THE CIRCUITS AND DEVICE PANELS MANUALS.

SITUATIONS THAT MAY ARISE DURING OPERATION:

Problems	Possible causes	Solution
It does not deliver oxygen	Empty cylinder	Re-charge the cylinder
	Pressure reducer not working	Change the reducer
	Problems inside the flowmeter box	Have the device checked by Tecno-gaz
It does not deliver nitrous oxide	No oxygen	Charge the cylinder
	Pressure reducer not working	Change the reducer
Nitrous oxide gauge pointing upwards	Incorrect manoeuvre	Clear the 'FLOW' knob to zero Restore correct operation
	Internal problem	Have the device checked by Tecno-gaz

10 PROCEDURES FOR AFTER SALE SERVICE

In case of damage or for overhaul contact directly the phone service of:
 TECNO –GAZ S.p.A.
 Strada Cavalli 4, 43038, Sala Baganza, Parma, ITALIA.
www.tecnogaz.com

PHONE	+39 0521 83.80
FAX	+39 0521 83.33.91
@	cme2@tecnogaz.com

The service staff shall decide whether the return to the manufacturer or the intervention of a technician is necessary; after checking the device the service staff will draw up a quote to be submitted to the distributor which, on its turn, will submit it to the final customer for subscription.

Upon reception of the subscribed quote the device will be repaired and then shipped back within the times indicated on the quote form.

In case of shipment of the device to the manufacturer follow the compulsory indications below:

- Use the original packaging, in case you do not have it anymore, use a suitable packaging. The goods shipment risk is charged to the sender.
- Only send the flow meter box and the pressure reducers, placed individually in clean cellophane.
The reducers must not be contaminated (detergents, alcohol, oils ...). If assistance does not consider the packaging to be suitable, the reducers will be scrapped.
- Write down and include into the package a document describing accurately the anomaly or the service required.
- Free port shipment is required, otherwise the supported transport costs will be charged.

All no original packages we will receive shall be disposed of.

The machine will be shipped back in its original packaging (the cost for the packaging will be charged to you) through the customer's forwarder.

TABLE DES MATIERES

- 1. UTILISATION ET USAGE PREVU**
- 2. SECURITE**
 - 2.1 MARQUAGE DE SECURITE
 - 2.2 DISPOSITIFS DE SECURITE
 - 2.3 MANUTENTION
 - 2.4 ECOULEMENT
- 3. DONNES TECHNIQUES**
- 4. DESEMBALLAGE**
- 5. DESCRIPTION DES COMPOSANTS**
 - 5.1 LISTE DES COMPOSANTS FOURNIS
 - 5.2 COMPOSANTS DE VERSIONE MEUBLE
 - 5.3 COMPOSANTS DE VERSIONE MURALE
 - 5.4 INTERFACE UTILISATEUR
 - 5.5 MASQUES
 - 5.6 MESURES DE MASQUE
 - 5.7 CIRCUIT DE MASQUES
- 6. INSTALLATION**
 - 6.1 INSTALLATION MASTER FLUX PLUS SUR MEUBLE
 - 6.2 INSTALLATION MASTER FLUX PLUS MURAL
 - 6.3 RACCORDEMENT DES CIRCUITS ET DES ACCESSOIRES
 - 6.4 EVACUATION DES GAZ EXHALES
 - 6.4.1 RACCORDEMENT DIRECT A L'EXTERIEUR DU CABINET
 - 6.4.2 RACCORDEMENT A L'ASPIRATEUR CHIRURGICAL
- 7. FONCTIONNEMENT DE L'APPAREIL**
 - 7.1 TABLEAU DES COMMANDES
 - 7.2 MODE D'EMPLOI
 - 7.3 REANIMATION AVEC LE MASTER FLUX PLUS
- 8. ENTRETIEN**
 - 8.1 REMPLACEMENT DES BOUTEILLES
 - 8.2 NETTOYAGE
 - 8.3 ENTRETIEN PROGRAMME
- 9. SIGNALISATIONS**
- 10. PROCEDURES POUR LE SERVICE ET L'ASSISTANCE**

USAGE PREVU

Le MASTER FLUX PLUS est un dispositif pour l'administration d'un mélange de O₂ et de N₂O pour le patient, qui est utilisé dans les techniques de sédation consciente / analgésie sédative.

UTILISATION

Dans le mélange administré les valeurs de concentration sont :

O₂ ≥ 30%

N₂O ≤ 70%

L'administration est effectuée avec un masque nasal, pour inspirer le mélange, le patient doit respirer activement par le nez.

La sédation consciente est indiquée pour tous les patients du cabinet dentaire, aussi bien pour les adultes que pour les enfants.

La sédation consciente permet aux patients de se soumettre à des soins dentaires en limitant la peur et l'état d'anxiété que tous les patients éprouvent lorsqu'ils entrent dans un cabinet dentaire.



ELLE N'EST PAS INDIQUEE

- EN CAS DE GROSSESSE
- POUR LES PATIENTS TOXICODEPENDANTS
- OU AVEC DE GRAVES INFECTIONS PULMONAIRES
- CEUX AYANT DE GRAVES MALADIES MENTALES.



Il MASTER FLUX PLUS doit être utilisé uniquement par un personnel médical ayant reçu une préparation spécifique.



Ne pas utiliser ce dispositif pour l'administration d'anesthésie générale ou comme une partie ou en association d'un système général d'anesthésie.



La loi limite la vente de ce dispositif uniquement aux médecins et dentistes.

ATTENTION



Ne pas essayer de réparer, modifier ou de calibrer ce dispositif.
La réparation non autorisée, l'altération ou l'abus de ce dispositif a des répercussions négatives sur les prestations et rend la garantie non valable.



Avant chaque utilisation, vérifier le raccordement correct des gaz d'alimentation



Le dispositif administre des médicaments uniquement pour la technique de la sédation consciente.



Les contre-indications sur l'utilisation du médicament sont reportées sur la fiche de sécurité et sur la documentation annexée à la fourniture du médicament. Si elles sont absentes, les réclamer au fournisseur du gaz.



Ne pas enlever la plaquette



Ne pas remplacer les réducteurs fournis par d'autres non fournis par le fabricant

2

SECURITE

L'utilisation du dispositif Master Flux Plus doit être associée à l'utilisation de PULSE OXIMETER, qui doit être de routine pendant la sédation consciente. La signification de la lecture des valeurs relevées:



Niveaux de saturation de O2	Degré d'hypoxie
≥ 95%	Aucune hypoxie
90-94%	Hypoxie légère
85-89%	Hypoxie modérée
84%	Hypoxie grave

2.1 Marquage de sécurité

Le dispositif est conforme à la Directive 93/42 CEE modifications et intégrations. La déclaration de conformité est annexée au dispositif.

2.2 Dispositifs de sécurité

Le dispositif est équipé de dispositifs de sécurité:

- Si l'on réduit la pression de l'oxygène (O₂), la distribution du protoxyde d'azote (N₂O) s'interrompt automatiquement.
- Un système de mélange incorporé règle l'N₂O de manière à ce qu'il y ait toujours une quantité minimum d'O₂ équivalente au moins à 30 % dans le mélange de gaz.
- Si le flux du mélange de gaz s'interrompt, le patient aspire l'air par l'extérieur, par l'intermédiaire d'une soupape de sécurité prévue à cet effet.
- Si le flux devait changer de direction, en retournant vers le dispositif, une soupape unidirectionnelle protège le patient d'une réaspiration des gaz exhalés et des accumulations d'anhydride carbonique (CO₂).
- Le bouton sélecteur de configuration du flux contrôle le flux total, règle automatiquement les flux d'oxygène et de protoxyde d'azote dans le pourcentage configuré.
- Le bouton 'FLUSH' permet de distribuer des flux importants d'oxygène pur.

AVERTISSEMENTS & NOTIONS UTILES



PENDANT QUE LA SOUMISSION DE GAZ EST INDISPENSABLE D'ETRE TOUJOURS PRESENTS, CONTROLER LES FLUX DES GAZ D'OXYGENE ET DE PROTOXYDE D'AZOTE, EN VERIFIANT LES VALEURS DE FLUX REPORTEES PAR LES BORNES ET LA POCHE DE CONTROLE.

2.3 Manutention



Pour déplacer le meuble Master Flux Plus, utiliser exclusivement les poignées fournies.



Figura 1

	<p>Ne pas pousser le meuble sans utiliser les poignées prévues à cet effet.</p>
	<p>Ne pas s'asseoir ni poser de poids sur le meuble.</p>
	<p>Avant de déplacer le meuble, ranger soigneusement le masque et les tuyaux dans les systèmes spécifiques de fixation, afin d'éviter tout risque de trébuchement ou rupture.</p>

2.4 Ecoulement

Éliminer l'emballage, le dispositif et les composants individuels conformément aux normes en vigueur dans le pays d'utilisation, pour le traitement et l'élimination des déchets potentiellement biocontaminants.

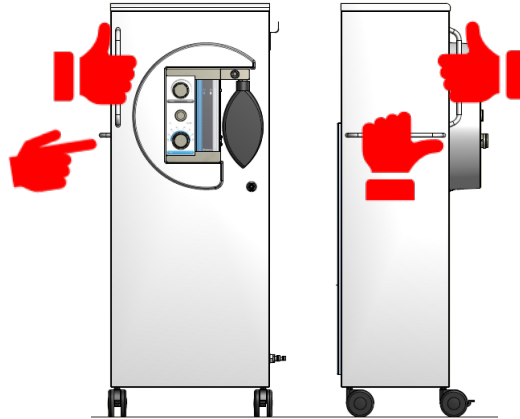
Ne pas disperser le matériau de l'emballage dans l'environnement.

Le dispositif ne contient aucune partie électrique / électronique et ne contient pas de batterie.

3

DONNEES TECHNIQUES

ALIMENTATION

Pression d'alimentation	3.5 bars \cong 50 PSI (max 6 bars \cong 87 PSI)
Débit maximum	10 l/min. (litres à la minute)

POIDS DU MASTER FLUX PLUS SUR MEUBLE:

Poids sans bouteilles	46 Kg
Poids maximum des cylindres sur les roues	180 Kg
Poids maximal durable du compartiment supérieur du cylindre	45 Kg

BOUTEILLES POUR MASTER FLUX PLUS SUR MEUBLE:

Hauteur maximum	950 mm
Diamètre maximum	140 mm

POIDS DU MASTER FLUX PLUS MURAL:

Poids du boîtier débitmétrique	6,3 Kg
--------------------------------	--------

DEBITMETRE

Répétabilité	+/-10% flow indicated
--------------	-----------------------

Lecture correcte: en ligne avec le dessus plat.

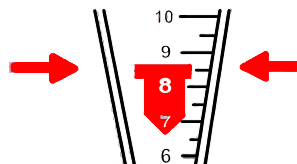

CONSOMMATIONS:

Ci-dessous est indiqué un exemple de consommation à prendre comme référence théorique

BOUTEILLE A OXYGENE MEDICALE D'UNE CONTENANCE DE 10 L.
CHARGEE A LA PRESSION DE 200 Bars

VOLUME DISPONIBLE	2000 Litres gazeux
-------------------	--------------------

BOUTEILLE DE PROTOXYDE D'AZOTE D'UNE CONTENANCE DE 10 L.
CHARGEE AVEC 7 Kg DE GAZ LIQUIDE

VOLUME DISPONIBLE	4600 Litres gazeux
-------------------	--------------------

EN CONFIGURANT:

DISTRIBUTION	10 NI/min
MELANGE	50 %

AUTONOMIE:

OXYGENE	400 min
PROTOXYDE D'AZOTE	950 min



Sur la base des moyennes de consommation de gaz, TECNO-GAZ recommande de remplacer le cylindre d'oxyde nitreux par 2 bouteilles d'oxygène.

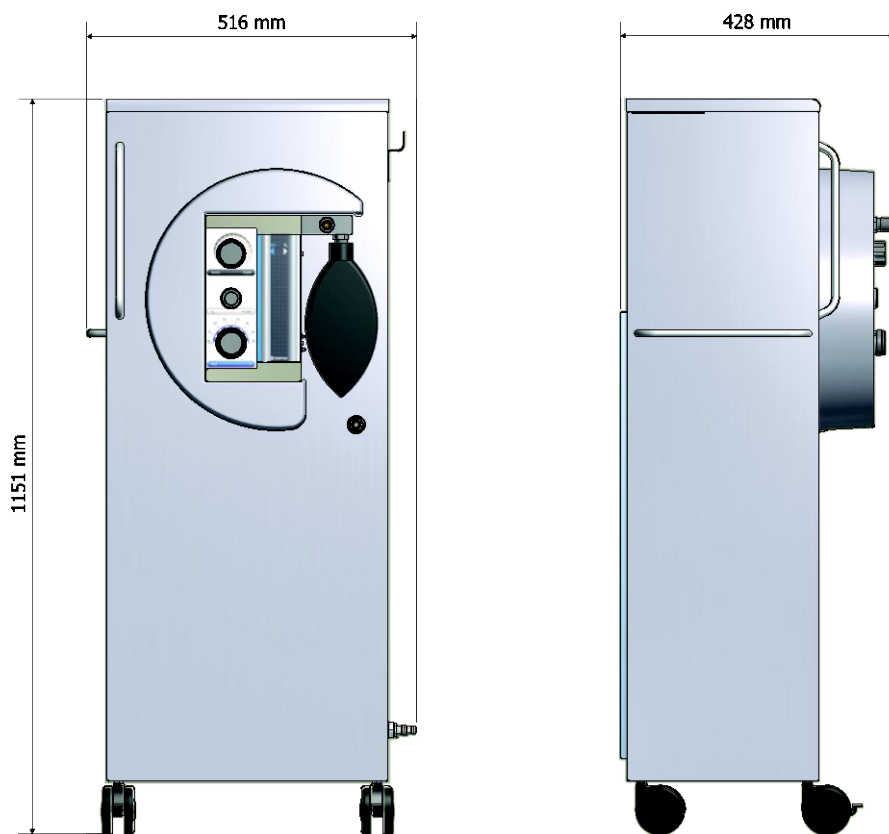

Figure A

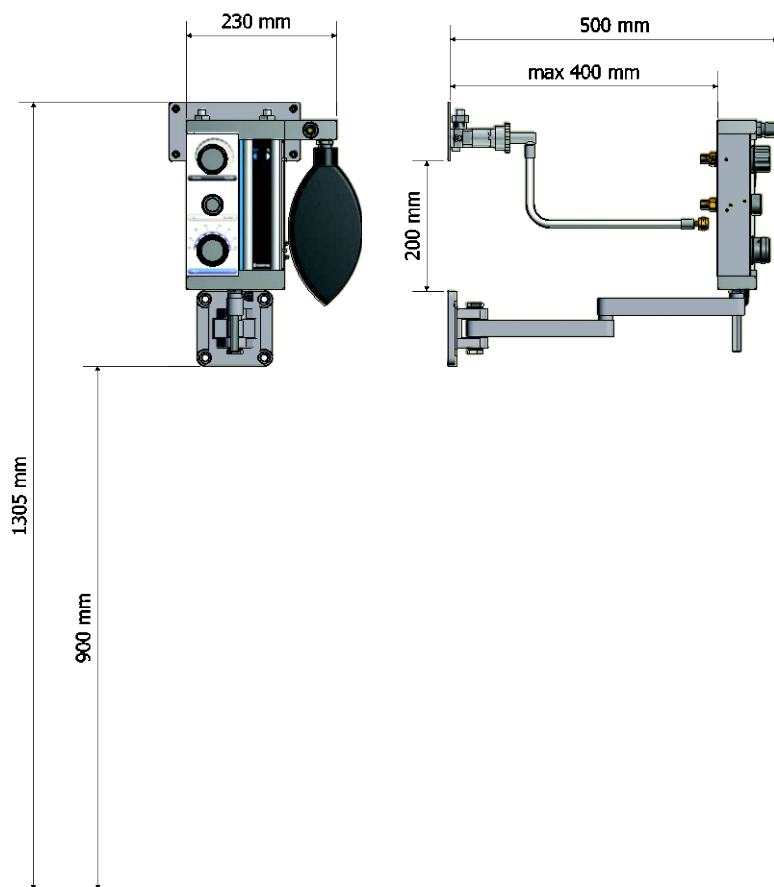

Figure B

04

DESEMBALLAGE



IL N'EST PAS AUTORISÉ DE SUPERPOSER LES MEUBLES MASTER FLUX PLUS



L'emballage ne doit pas subir de chocs et doit être manipulé avec soin en évitant de le faire rouler ou tomber.



Ne pas utiliser d'appareillages qui présentent des dommages évidents découlant du transport.



Enlever l'emballage et contrôler l'état de l'appareil.



L'emballage doit être préservé pendant toute la période de garantie.
Le constructeur n'accepte pas que le dispositif soit rendu sans emballage d'origine.



Les dispositifs emballés doivent être conservés dans des lieux secs et à une température comprise entre + 5/+ 40 °C.

05

DESCRIPTION DES COMPOSANTS

5.1

Liste des composants fournis

ARTICOLO	MF010ZMF Master Flux Plus a muro con Riduttori con attacchi Ossigeno AFNOR e Protossido Azoto UNI	SMFA301	SMFA301	SMFA301	MF009ZMF Master Flux Plus a mobile senza kit riduttori	MF006ZMF Master Flux Plus a mobile con Riduttori con attacchi Ossigeno AFNOR e Protossido Azoto UNI	1600ASD Master Flux Plus a mobile con Riduttori con attacchi Ossigeno e Protossido Azoto DIN	1600ASF Master Flux Plus a mobile con Riduttori con attacchi Ossigeno e Protossido Azoto AFNOR	1600AS Master Flux Plus a mobile con Riduttori con attacchi Ossigeno e Protossido Azoto UNI
MOBILE	SMFA301	SMFA301	SMFA301	SMFA301	2ZMFA0020	2ZMFA0020	2ZMFA0020	2ZMFA0020	2ZMFA0020
KIT MASTER	2ZZMFA0065	2ZZMFA0063	2ZZMFA0062	2ZZMFA0057	2ZMFA0059	2ZZMFA0058	2ZZMFA0061	2ZZMFA0060	
RIDUTTORE N₂O	SMFA360	SMFA360	SMFA360		MF011ZMF	MF011ZMF	MK005ZMF	MF011ZMF	
RIDUTTORE O₂	SMFA361	SMFA358	MF003ZMF		1513A4F	1513A4D	1513A4F	1513A4	
MASCHERINE	<p>MF820ZMF Master Flux circuito</p> <p>MF824ZMF Circuito aspirazione Master Flux Plus (new)</p> <p>MF835ZMF Intelliflux 1 maschera completa Master Flux plus 0-4 anni</p> <p>MF836ZMF Intelliflux 2 maschera completa Master Flux plus 4-10 anni</p> <p>MF837ZMF Intelliflux 3 maschera completa Master Flux plus >10 anni</p>								

5.2

COMPOSANTS de version meuble

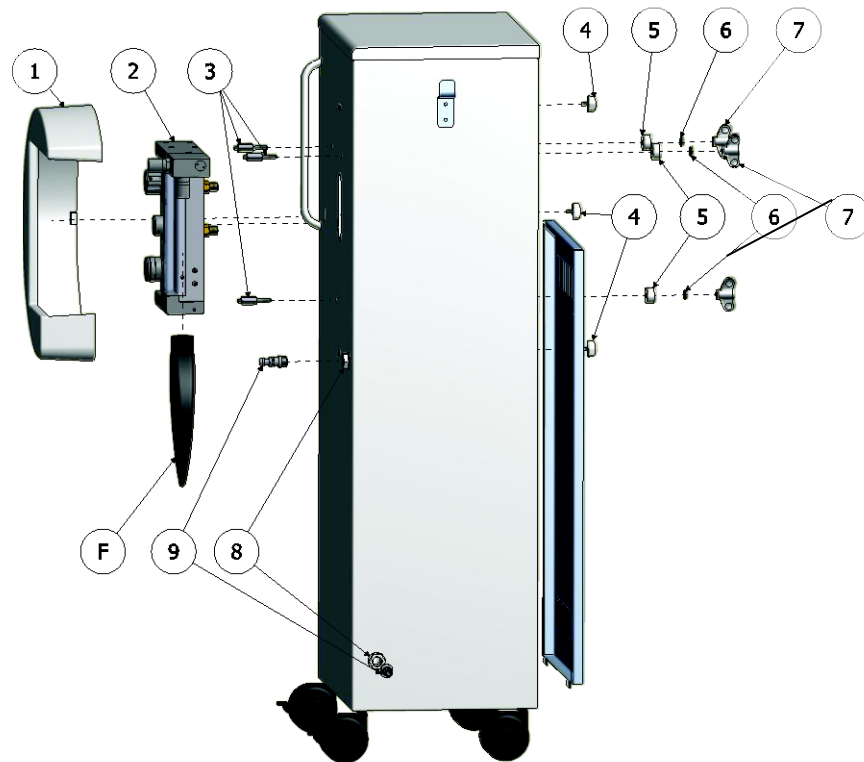

Figure 2

FIGURE	POSITION	Q.TE	CODE	DESCRIPTION
3	1	1	SMFA144	COUVERTURE EN PLASTIQUE
	2	1	SMFA506	BOITIER FLUXMETRIQUE
	3	3	SMFA223	ECARTEUR
	4	3	CM25021	VIS A AILETTES M5
	5	3	3MECQ0010	ECARTEUR
	6	3	CM20015	RONDELLE
	7	3	CM25019	ECROU A AILETTES M6
	9	2	SMFA237	EMBOUT D'ELIMINATION DE GAZ

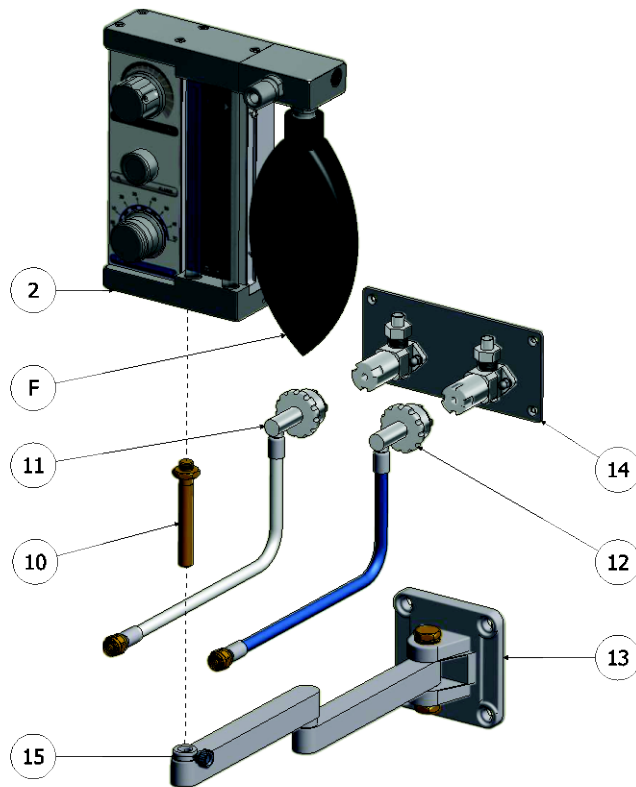

Figure 3-4

MURAL (Figure 3-4)

FIGURE	POSITION	Q.TE	CODE	DESCRIPTION
4	10	1	SMFA313	PIVOT
	11	1	SMFA364	TUYAU O ₂
	12	1	SMFA365	TUYAU N ₂ O
	13	1	SMFA301	SUPPORT MURAL
	14	1	SMFA501	PLAQUE MURALE
	15	1	CM30011	BOUTON DE FIXAGE PIVOT

5.4

INTERFACE UTILISATEUR

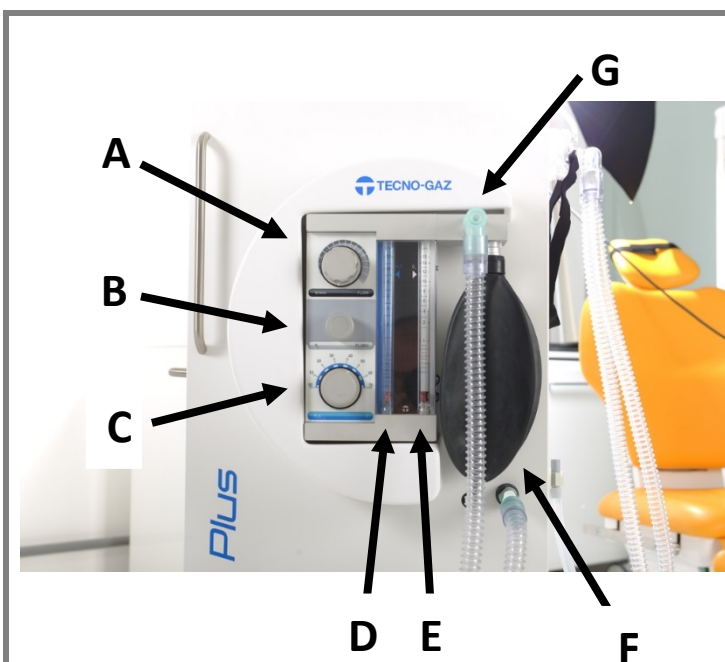

Figure 5

A	BOUTON SELECTOR FLOW
B	BOUTON FLUSH
C	BOUTON SELECTEUR % N ₂ O
D	INDICATEUR DE DEBIT N ₂ O
E	INDICATEUR DE DEBIT O ₂
F	BALLON EN CAOUTCHOUC
G	EMBOUT DE RACCORDEMENT DU MASQUE

5.5

MASQUES

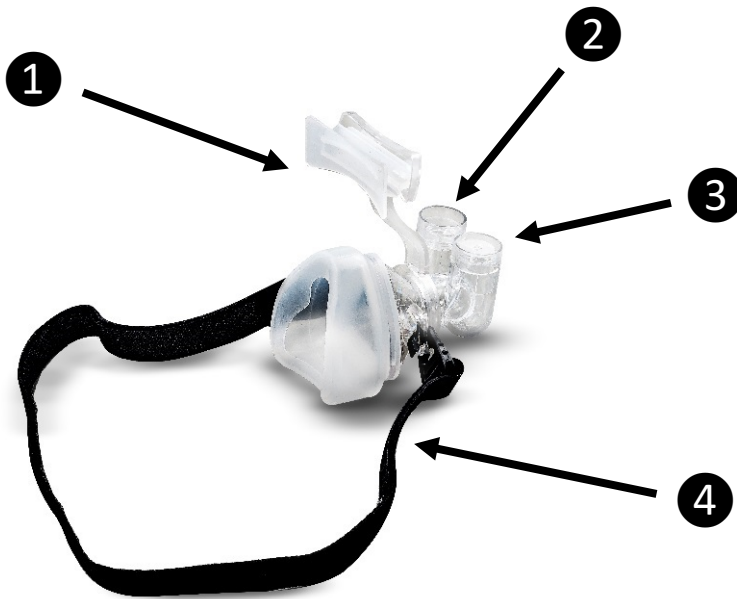

Figure 6

①	Zone de soutien pour le front du patient
②	Entrée de gaz avec clapet anti-retour
③	Sortie de gaz avec clapet anti-retour + flèche imprimée sur le PC pour indiquer le sens d'écoulement
④	Bande élastique en velcro avec crochets en plastique

5.6

MESURES DE MASQUE





			
MF835ZMF	MF836ZMF	MF837ZMF	MF838ZMF
MASQUE 1	MASQUE 2	MASQUE 3	MASQUE 4
0-4 ans	4-10 ans	>10 ans	

Figure 7

5.7

CIRCUIT DE MASQUES



Figure 8

CIRCUIT COMPLET DE MASQUES

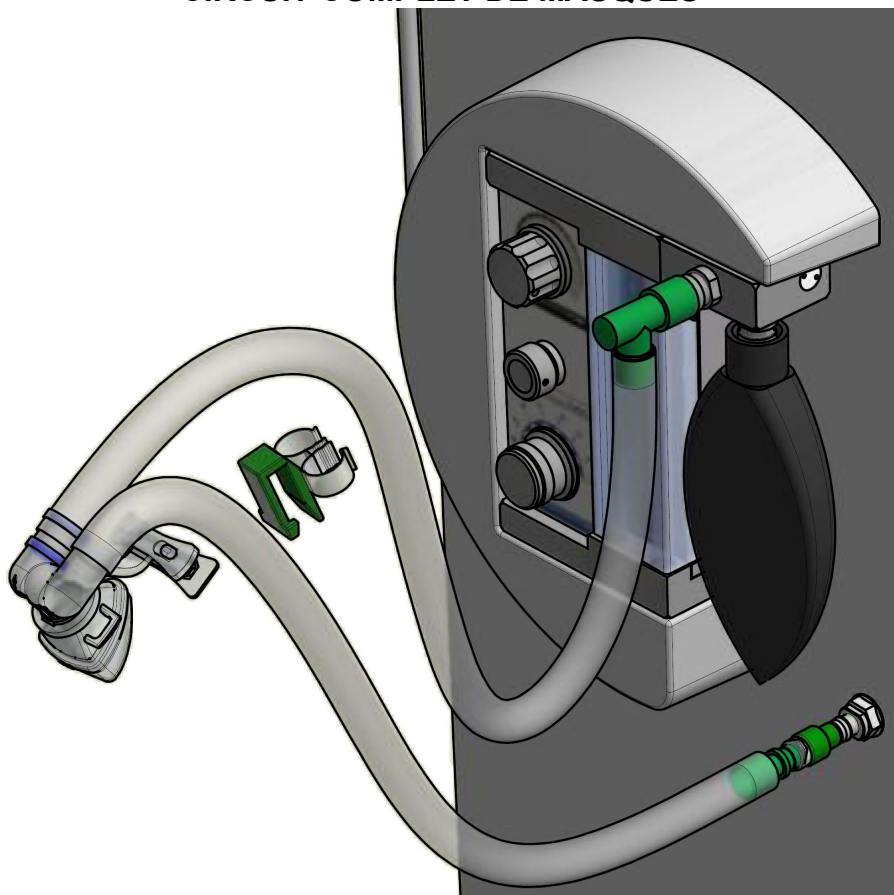

Figure 9



Pour des pièces de composants individuels,
voir le manuel d'utilisation pour "Circuits et masques".



Enlever l'emballage et contrôler l'état de l'appareil.

Ne pas utiliser des appareils qui présentent des dommages évidents dus au transport.

6.1 Installation de MASTER FLUX PLUS sur meuble

MONTAGE DU BOÎTIER DÉBITMÉTRIQUE (Figure 2)

voir le guide rapide joint 0ZMFI0007

Visser les 3 écarteurs en acier **(3)** sur le boîtier débitmétrique **(2)**.

Enlever les protections des nipples d'alimentation du boîtier débitmétrique.

Monter le boîtier débitmétrique sur le meuble en introduisant les écarteurs en acier **(3)** dans les trous du meuble prévus à cet effet, les fixer au meuble en utilisant 3 écarteurs en plastique **(5)**, 3 rondelles **(6)** et les 3 écrous à ailettes **(7)** fournis.

MONTAGE DE LA COUVERTURE FRONTALE (Figura 2 Pos 1)

voir le guide rapide joint 0ZMFI0007

Positionner la couverture en plastique à proximité des trois trous qui se trouvent sur le meuble. Fixer la couverture en plastique en serrant les trois vis à ailettes **(4)** fournies.

MONTAGE DE L'EMBOÛT D'ÉVACUATION

voir le guide rapide joint 0ZMFI0007

Si l'on utilise le tuyau d'évacuation des gaz exhalés, serrer l'embout fourni aux raccords en plastique.

MONTAGE DES BOUTEILLES (NON FOURNIES) (FIGURE 10)

Fixer les réducteurs sur les bouteilles (voir le manuel d'instruction des réducteurs).

Pour les bouteilles de **5 l** mettre l'étagère et la fixer par l'intermédiaire des arrêts prévus à cet effet.

Pour les bouteilles de **10 et 14 l** placer l'étagère au fond du meuble.

Les manomètres des réducteurs **(M)** doivent être positionnés de manière à être visibles par l'opérateur.

Bloquer les bouteilles au meuble à l'aide de la bande Velcro spéciale fournie.

Visser l'écrou du tuyau du **réducteur O₂ (R1)** avec le nipple d'alimentation du boîtier débitmétrique **(I) (FILETAGE DROIT)**.

Visser l'écrou final du tuyau du **réducteur N₂O (R2)** avec le nipple d'alimentation du boîtier débitmétrique **(H) (FILETAGE GAUCHE)**.

Fermer le volet arrière par l'intermédiaire des deux aimants situés sur la partie supérieure.

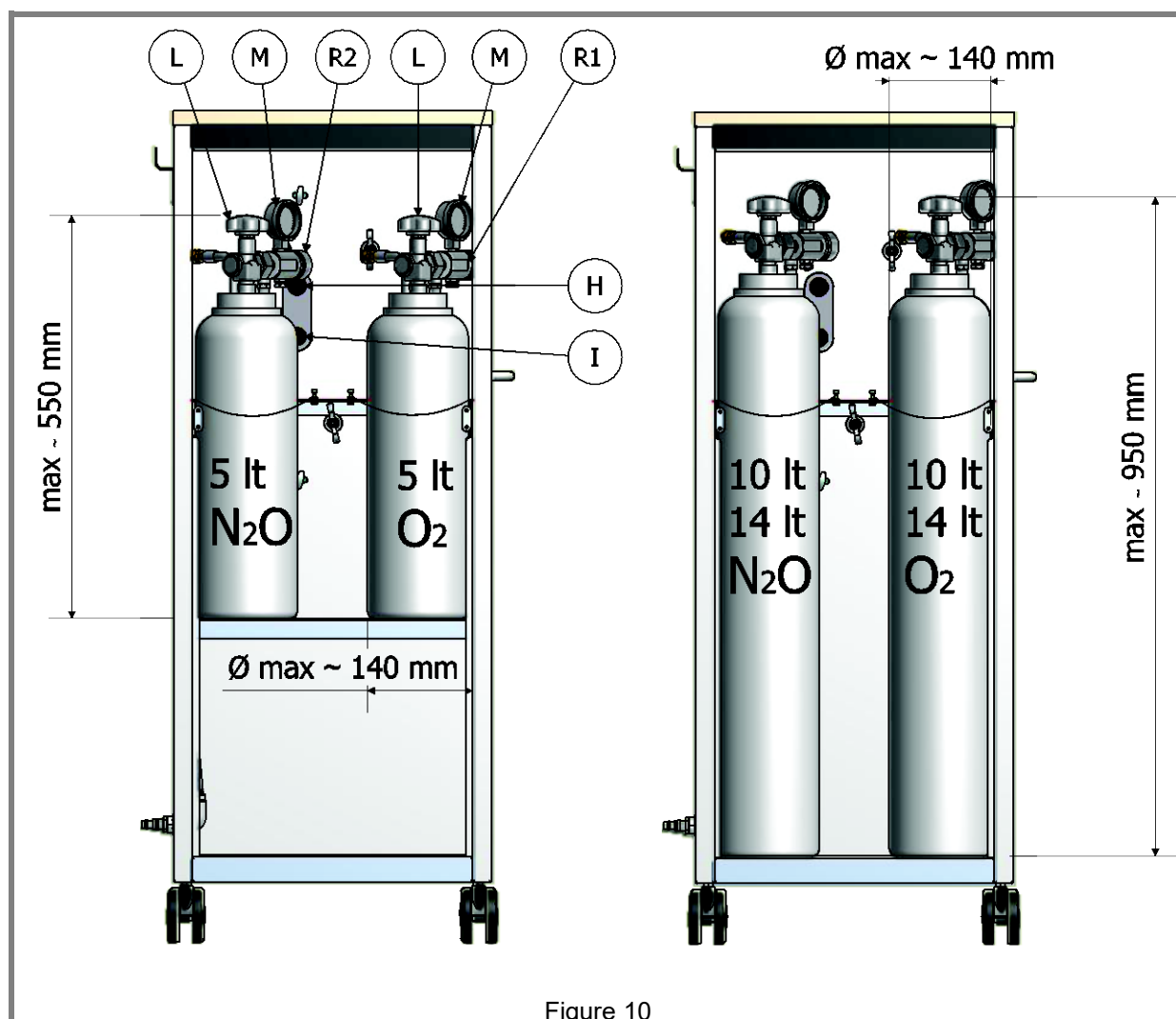

Figure 10

FIGURE	POSITION	Q.TE	CODE	DESCRIPTION
6	R1	1	1513A4	REDUCTEUR O ₂ (ITA)
	R2	1	MF011ZMF	REDUCTEUR N ₂ O (ITA)
	L	1		SOUPAPE
	M	1		MANOMETRE

6.2 Installation de MASTER FLUX PLUS mural

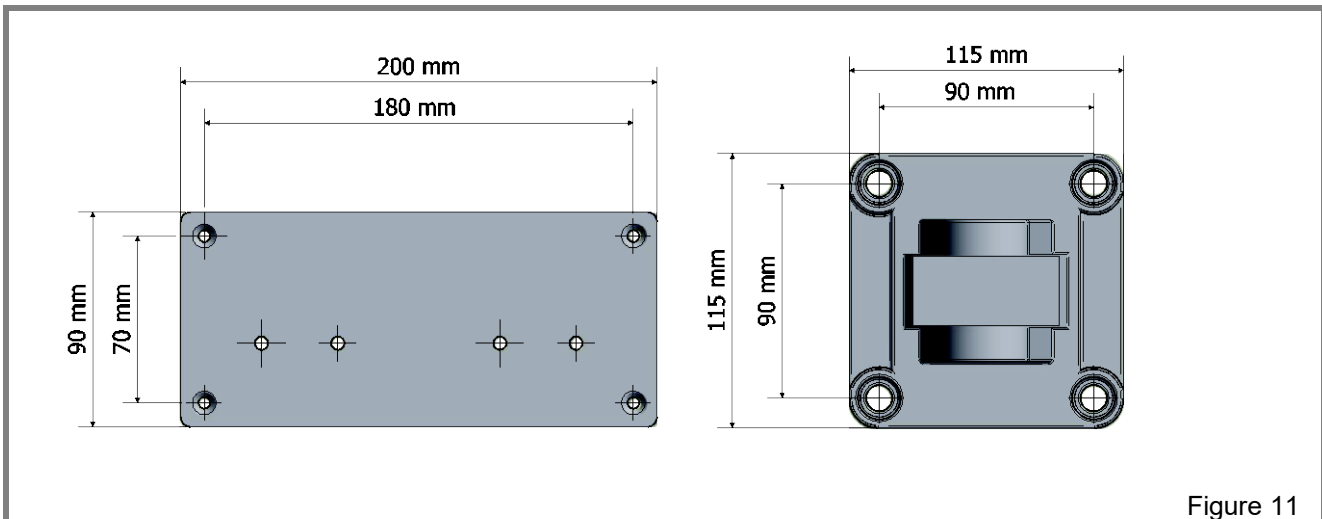

Figure 11



Figure 12

(FIGURE 5, 10)

Fixer le SUPPORT MASTER FLUX PLUS sur le mur (13) en utilisant 4 tasseaux pour mur $\varnothing 14$ mm M8.

Fixer la PLAQUE MASTER FLUX PLUS sur le mur (14) avec 4 tasseaux pour mur $\varnothing 8$ (mm).

Visser à la base du boîtier débitmétrique le pivot (10).

Insérer le pivot sur la partie finale du support (15).

Bloquer le pivot sur le support avec le bouton fileté prévu à cet effet.

Raccorder l'écrou du tuyau O₂ avec le nippel d'alimentation O₂ situé sur le boîtier Débitmétrique (filetage GAUCHE).

Visser l'écrou du tuyau N₂O avec le nippel d'alimentation N₂O sur le boîtier débitmétrique (filetage DROIT).

Raccorder les extrémités libres des tuyaux aux prises murales (appuyer sur les raccords et tourner pour bloquer l'enclenchement à la prise).

REMARQUES SUR L'INSTALLATION CENTRALISEE

L'installation doit être effectuée par des techniciens spécialisés, l'installation centralisée doit être effectuée conformément aux directives en vigueur Directive Européenne 93/42/CE

Raccorder la prise murale au point équipotentiel de l'installation électrique avec les connecteurs à œillet fournis.

Les réducteurs fournis doivent être raccordés aux bouteilles de l'installation centralisée.

La sortie du réducteur **N₂O** comprend un tuyau flexible sur lequel est accroché à l'extrémité un raccord mâle avec un filet **1/4" G** pour le raccordement à l'installation.

La sortie du réducteur **O₂** comprend un tuyau flexible sur lequel est accroché à l'extrémité un raccord mâle avec un filet **1/8" G** pour le raccordement à l'installation.

La plaque de fixation n'est pas fournie.

6.3 Raccordement des circuits et accessoires:

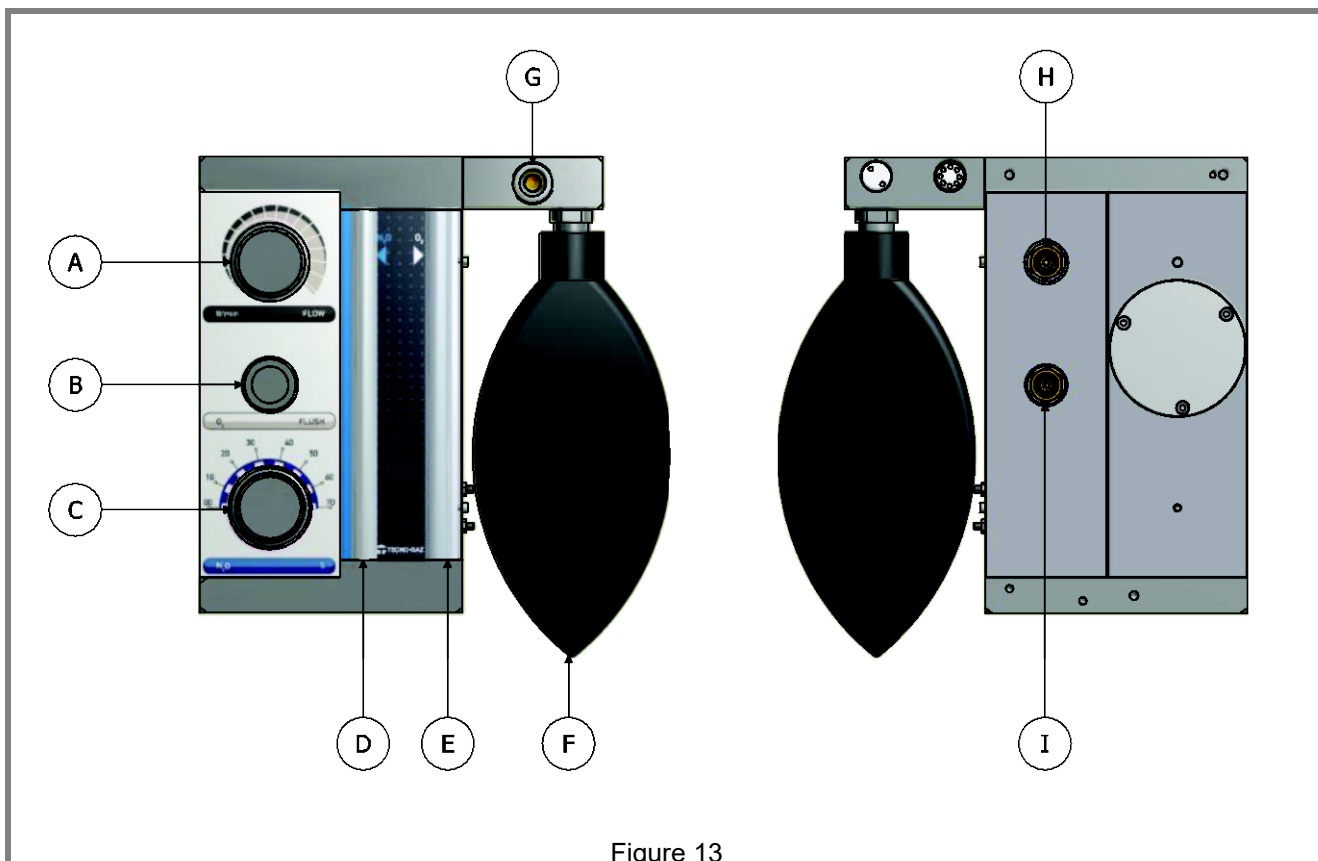

Figure 13

FIGURE	POSITION	Q.TE	CODE	DESCRIPTION
8	A	1		BOUTON SELECTEUR 'FLOW'
	B	1		BOUTON 'FLUSH'
	C	1		BOUTON SELECTEUR '% N2O'
	D	1		INDICATEUR DE DEBIT O2
	E	1		INDICATEUR DE DEBIT N2O
	F	1	3MEDN0002	BALLON EN COUTCHOUC
	G	1		EMBOUT DE RACCORDEMENT DU MASQUE
	H	1		NIPPLE N2O
	I	1		NIPPLE O2

Raccorder le Ballon en caoutchouc (F) au boîtier débitmétrique, en l'introduisant avec pression dans l'embout prévu à cet effet.

Les kits des masques sont raccordés au dispositif au moyen de l'embout (G).

Le tuyau d'évacuation de gaz sera raccordé avec des modalités différentes en fonction du type d'évacuation de gaz utilisé. (voir 6.4 - EVACUATION DES GAZ EXHALES).

6.4 Evacuation des gaz exhalés:

Pour la sécurité de l'environnement de travail et des opérateurs, les gaz exhalés doivent être portés à l'extérieur de l'environnement de travail

Pour évacuer les gaz à l'extérieur, deux systèmes peuvent être utilisés

- Le raccordement direct à l'extérieur du cabinet
- Le raccordement à l'aspirateur chirurgical.

Il est important d'évaluer

- L'aptitude de l'aspirateur à évacuer des gaz (**N₂O** et **O₂**)
- L'évacuation de l'aspirateur doit être extérieure et aérée.

Vérifier la conformité des réglementations en vigueur dans le pays d'utilisation.

6.4.1 RACCORDEMENT DIRECT A L'EXTERIEUR DU CABINET

MASTER FLUX PLUS SUR MEUBLE

Visser l'embout (Figura 2 Pos 8/9) sur le meuble.

Eliminer la soupape fournie.

Raccorder le tuyau d'évacuation de gaz du circuit du masque à l'embout (Figura 15).

Raccorder le tuyau spiralé d'évacuation de gaz (Figure 14), à l'embout du meuble.

Placer à l'extérieur l'extrémité du tuyau spiralé et vérifier la présence du filtre final (Figure 14 Pos 34).

MASTER FLUX PLUS MURAL

Raccorder le tuyau d'évacuation de gaz du circuit du masque à l'embout (Figure 14 Pos 36).

Placer à l'extérieur l'extrémité du tuyau spiralé et vérifier la présence du filtre final (Figura 14 Pos 34).

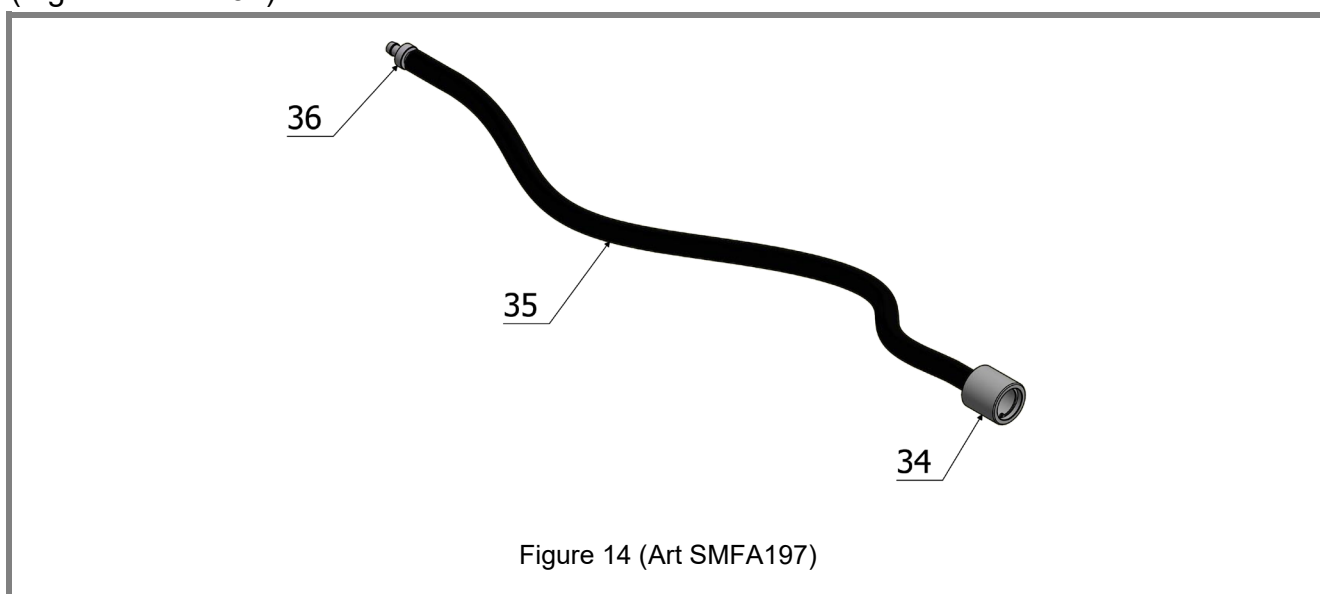

FIGURE	POSITIONE	Q.TE	CODE	DESCRIPTION
9	34	1	SMFA197	FILTRE - SMFA260
	35	1		TUYAU – SMFA199
	36	1		RACCORD – SMFA257



Figure 15

6.4.2 RACCORDEMENT A L'ASPIRATEUR CHIRURGICAL

MASTER FLUX PLUS SUR MEUBLE

Visser les tuyaux (Figure 2 Pos 8/9) sur le meuble.

Raccorder le tuyau d'évacuation de gaz du circuit du masque à la soupape fourni (Figure 17).

Raccordez le circuit d'aspiration (Figure 16) au raccord de tuyau.

Relier le raccord au tuyau de l'aspirateur chirurgical (Ø11 mm).

MASTER FLUX PLUS MURAL

Retirer le tube (Figure 16 Pos 43)

Connecter le tube, décharge de gaz du circuit du masque, à la vanne (Figure 16 Pos 44).

Connecter la valve au tube d'aspiration chirurgical (Ø11).

RÉGLAGE DE LA SOUPAPE

Tourner la bague percée de la soupape jusqu'à la fermeture des trous (Figure 16 Pos 44).

Démarrer la distribution des gaz en configurant ~10 l/min

Démarrer l'aspirateur chirurgical, configurer la valeur minimum d'aspiration.

Observer le ballon (Figure 13 Pos F).

Tourner le levier de la soupape en fermant progressivement jusqu'à obtenir l'état idéal du ballon "MOITIE PLEIN MOITIE VIDE".

ATTENTION

En variant les flux distribués, il peut s'avérer nécessaire de régler les flux corrects d'aspiration des gaz exhalés.

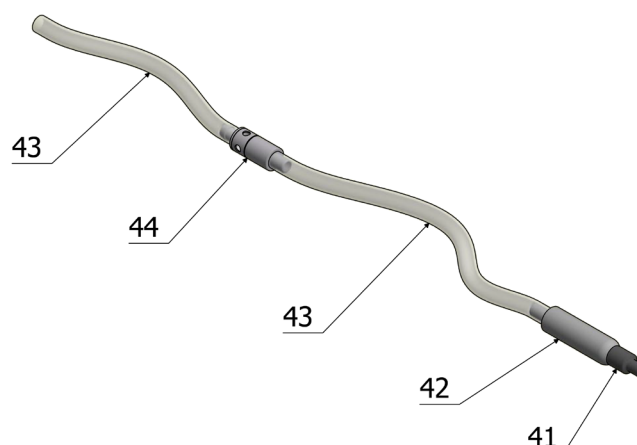

Figure 16 (Art MF824ZMF)

FIGURE	POSITION	Q.TE	DESCRIPTION
9A	41	1	REDUCTEUR
	42	1	PARTIE TERMINALE
	43	2	TUYAU
	44	1	VANNE



Figure 17

7

FONCTIONNEMENT DE L'APPAREIL

7.1 TABLEAU DES COMMANDES

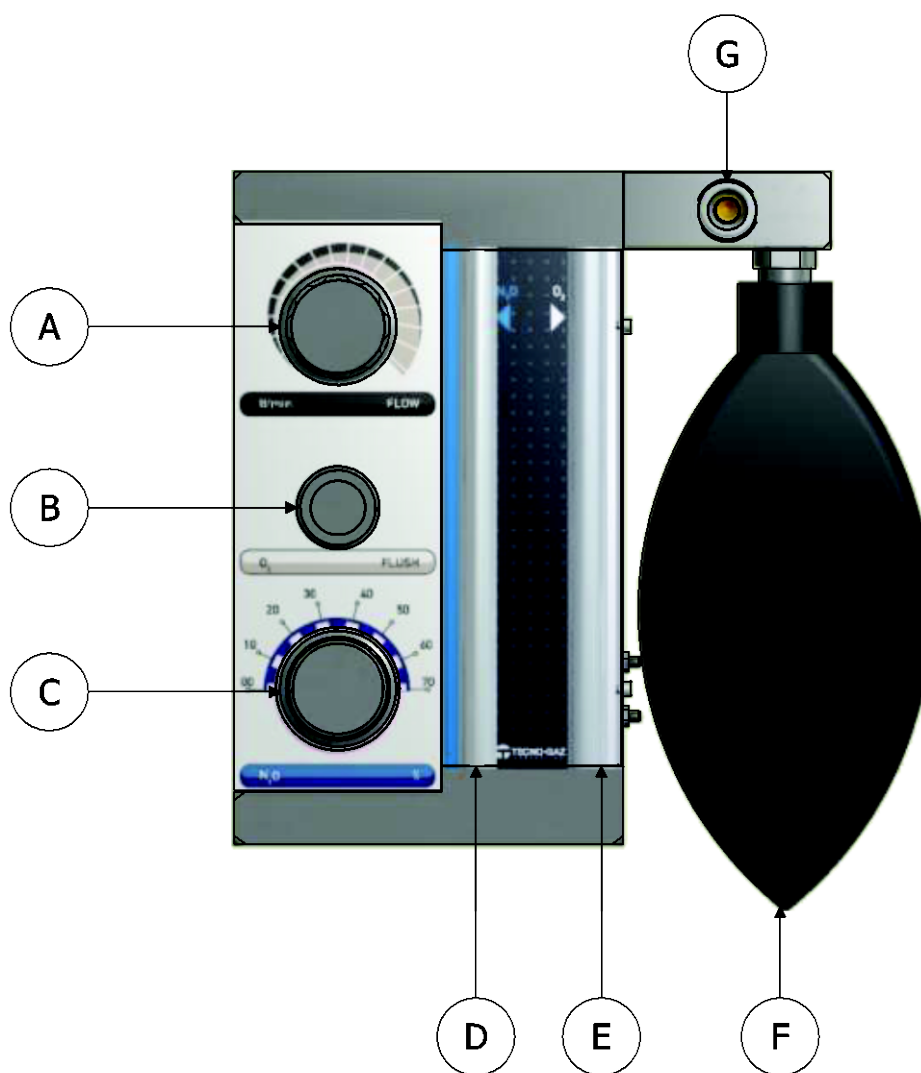

Figure 18

TOUCHES COMMANDE (FIGURA A10)

A	REGLAGE DU FLUX DISTRIBUE
B	BOUTON D'URGENCE ' FLUSH '
C	REGLAGE % MELANGE PROTOXYDE D'AZOTE

ELEMENTS DE CONTROLE

E	FLUX PROTOXYDE D'AZOTE PUR
D	FLUX D'OXYGENE PUR
F	BALLON (VERIFICATION - FLUX ADAPTE AU PATIENT)

Avant de commencer à utiliser le dispositif MASTER FLUX PLUS dans la version sur meuble, bloquer les roues munies de frein en appuyant vers le bas les languettes correspondantes.

S'il s'avère nécessaire de déplacer l'appareil, (par exemple dans une autre pièce), débloquer les roues et pousser délicatement le dispositif en utilisant les poignées, voir le paragraphe 2.3.



Évitez les chocs et les mouvements brusques susceptibles de provoquer des chutes accidentelles.



Déplacer et positionner le MASTER FLUX PLUS uniquement sur les surfaces lisses et sans inclinaisons.



Vérifier la stabilité des bouteilles et la fixation correcte.



Fermer les bouteilles avant de manutentionner le dispositif.



Ne pas utiliser les poignées pour soulever le dispositif.



Ne faites pas glisser le périphérique en utilisant les poignées.



Ne pas exposer les commandes à des coups involontaires.

Lors de l'utilisation de MASTER FLUX PLUS dans la version murale, il est possible de déplacer et d'orienter le boîtier débitmétrique à souhait, en prenant la poignée prévue à cet effet (Figure 4 Pos. 10).



**NE PAS S'APPUYER ET NE POSER AUCUN OBJET SUR LE BOITIER FLUXMETRIQUE (AUSSI BIEN POUR LA VERSION SUR MEUBLE QUE CELLE MURALE).
NE PAS FORCER LE BRAS DANS LA VERSION MURALE.**



OUVRIR LENTEMENT LES SOUPAPES DES BOUTEILLES O₂ ET N₂O (TOURNER DANS LE SENS ANTIHORAIRE LES ROBINETS).

Lire la pression sur les manomètres des réducteurs de pression, (voir DONNEES TECHNIQUES) pour estimer l'autonomie de la bouteille d'oxygène.

Vérifier que le ballon et les tuyaux soient bien insérés dans leurs raccords.

Choisir le masque adapté au patient.

Placer le masque en le faisant adhérer autour du nez du patient.

Fixer le masque par l'intermédiaire du bloque-tuyau autoserrant derrière l'appui-tête du fauteuil.

Vérifier que les tuyaux du circuit du masque ne subissent pas de pliures ou d'étranglements.

L'opérateur doit se positionner afin d'avoir le contrôle visuel de:

- **Ballon en caoutchouc** (Figure 18 Pos. F)
- **Indicateurs de débit** (Figure 18 Pos. D, E)



Pendant la thérapie, contrôler constamment les flux visualisés par les débitmètres (Figure 13, Pos. D, E).



Avant de s'éloigner du patient, même pour de brefs moments, interrompre la sédation.

Contrôler que l'indice du bouton sélecteur (Figure 18 Pos C) %N₂O indique 0.

Administer, en se servant du bouton sélecteur FLOW (Figure 18 Pos A) un flux de 3 l/min d'oxygène pendant 30 secondes.

COMMUNIQUER AU PATIENT D'INSPIRER ET D'EXPIRER AVEC LE NEZ.

Utiliser le bouton sélecteur **FLOW**, pour régler le flux.

Varié progressivement le flux, évaluer l'état du ballon (Figure 18 Pos F), le ballon doit prendre une forme que nous définirons de **moitié plein moitié vide**.

Faire respirer le patient au moins une minute avant d'évaluer le flux.

Lorsque le flux idéal est déterminé par la capacité pulmonaire du patient, régler la soupape d'élimination de gaz comme indiqué au paragraphe 6.4 'Evacuation des gaz exhalés'.

Avec le bouton sélecteur % (Figure 18 Pos C) il est possible de changer le pourcentage de protoxyde d'azote.

Les débitmètres visualisent les litres/min de Protoxyde d'azote et d'Oxygène distribués.

La somme des deux débits est celle configurée initialement en fonction de la capacité respiratoire du patient.



Les indications fournies ci-dessous sont des exemples d'administration. Chaque utilisateur doit configurer le débit et le pourcentage selon le patient auquel il administre le médicament.

DETAILS DE THERAPIE POUR LES ENFANTS:

Le flux pour les ENFANTS tourne autour de 4-5 l/min.

- Tourner dans le sens horaire le bouton sélecteur "FLOW" en configurant le flux de 4/5 l/min et laisser inspirer pendant ~1 minute.
- Vérifier le flux configuré sur la borne O₂ (Figure 18 Pos E).
- Le ballon doit être moitié plein moitié vide.

DETAILS DE THERAPIE POUR LES ADULTES:

Le flux pour les ADULTES tourne autour de 6-8 l/min.

- Tourner dans le sens horaire le bouton sélecteur "FLOW" en configurant le flux de 6/-8 l/min et laisser inspirer pendant ~1 minute.
- Vérifier le flux configuré sur la borne O₂ (Figure 18 Pos E).
- Le ballon doit être moitié plein moitié vide.

Avec la poignée (Figure 18 Pos C) % N₂O administrer le protoxyde d'azote, configurer 20%, attendre quelques minutes et observer les réactions du patient.

Si le patient n'est pas calmé, augmenter progressivement le pourcentage (ex 30%).

LE POURCENTAGE DE PROTOXYDE D'AZOTE ADMINISTRE AU PATIENT DOIT ETRE: LE PLUS BAS POSSIBLE POUR OBTENIR UNE BONNE SEDATION (BASE LINE).

Lorsque la BASE LINE du patient est établie, reporter la valeur du FLUX et le %N₂O sur le dossier médical, ces données seront utiles pour les prochaines visites.



**LE MELANGE DE GAZ ADMINISTRE AU PATIENT:
NE DOIT JAMAIS ETRE SUPERIEUR A 70% DE PROTOXYDE D'AZOTE
NE DOIT JAMAIS ETRE INFERIEUR A 30% D'OXYGENE**



Si le patient éprouve des symptômes de mal être (nausée, vertiges, mal de tête), interrompre la thérapie immédiatement.

Sur le dispositif est présent le bouton sélecteur "FLUSH" (Figure 13 Pos B).

En appuyant sur ce bouton le ballon se remplira d'oxygène.

En appuyant sur le ballon, des quantités élevées d'oxygène pur seront administrées au patient.

FIN DE LA THERAPIE

La thérapie s'achèvera lorsque le dentiste termine l'intervention sur le patient.

Pour conclure la thérapie:

- Interrompre la distribution de PROTOXYDE D'AZOTE en tournant le bouton sélecteur (Figure 18 Pos C) %N₂O (dans le sens horaire) en fin de course (0%).
- Administrer (comme au début de la thérapie) un flux de 3 l/min d'oxygène pendant 2 minutes
- Interrompre la distribution d'OXYGENE en tournant le bouton sélecteur (Figure 18 Pos A) FLOW (dans le sens horaire) en fin de course.
- Desserrer le bloque-tuyau autoserrant et enlever le masque au patient.

Avant de faire sortir le patient le tenir en observation (sale d'attente) pendant ~5÷10 minutes.

Le médecin pourrait considérer nécessaire d'augmenter le temps d'observation.

FERMETURE DES BOUTEILLES



Lorsque l'utilisation du dispositif est terminée il est IMPORTANT de fermer les bouteilles.



Fermer le robinet de la bouteille du Protoxyde (N₂O), (en tournant le sens horaire).



Fermer le robinet de la bouteille d'Oxygène (O₂), (en tournant le sens horaire).

STOCKAGE DES BOUTEILLES



À la fin de la journée, stockez les bouteilles dans un dépôt conformément aux lois en vigueur.

7.3 REANIMATION AVEC LE MASTER FLUX PLUS

*(KIT Art. 1504/A non fourni - Figure A11)



Les opérations de REANIMATION AVEC LE MASTER FLUX PLUS, devront être effectuées avec le bouton sélecteur %N₂O réglage du pourcentage de protoxyde d'azote, sur la position 0%.

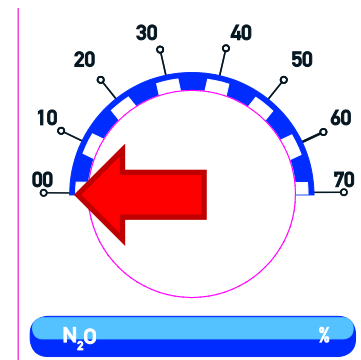

Ouvrir LENTEMENT la soupape de la bouteille de l'oxygène (tourner dans le sens antihoraire le robinet), vérifier que la bouteille du protoxyde d'azote soit fermée (tourner dans le sens horaire le robinet).

Enlever le kit masque du MASTER FLUX PLUS en l'enlevant du tuyau spiralé.

Introduire dans le tuyau spiralé, le raccord correspondant **(30)**.

Eloigner la sac **(F)** et mettre le bouchon **(T)**

Raccorder l'extrémité du tuyau pour l'oxygène thérapie **(31)** au raccord **(30)**.

Raccorder l'autre extrémité du tuyau pour l'oxygénothérapie à l'œillet inférieur du ballon de réanimation**(32)** avec le raccord prévu à cet effet.

Raccorder le masque **(33)**, à la soupape du ballon de réanimation.

Tourner le sélecteur **FLOW** pour envoyer l'Oxygène au flux souhaité, et contrôler les flux visualisés par les bornes.

Le débitmètre du protoxyde d'azote = 0

Le débitmètre d'oxygène = FLUX CONFIGURÉ

Mettre le masque sur le patient.

Agir sur la poche du ballon de réanimation en respectant les instructions de réanimation.

Lorsque l'utilisation du dispositif est terminée, il est **IMPORTANT** de fermer le robinet de la bouteille d'Oxygène (en tournant dans le sens horaire).

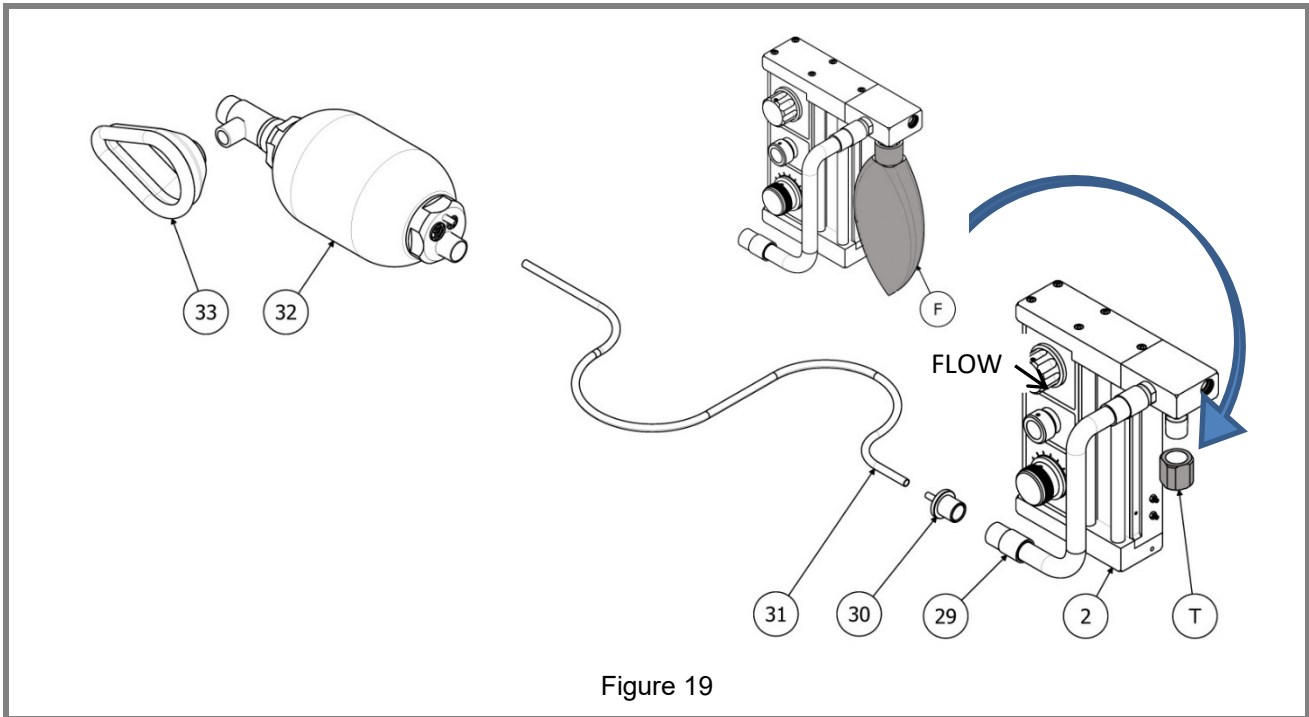

Figure 19

FIGURE	POSITION	Q.TE	CODE	DESCRIPTION
11	29	1	1504/A EN OPTION	TUYAU SPIRALE - CM88051
	30	1		RACCORD – SMFA278
	31	1		TUYAU D'OXYGENE – CM84022
	32	1		BALLON DE REANIMATION – 1025-2
	33	1		MASQUE DE REANIMATION – CM84014

8**ENTRETIEN****8.1****REPLACEMENT DES BOUTEILLES**

Si la pression des bouteilles est très basse ~10÷20 bars, remplacer ou recharger les bouteilles.



Nous recommandons de remplacer la bouteille d'oxyde nitreux tous les 2 réservoirs d'oxygène.

Fermer lentement les soupapes (tourner dans le sens antihoraire).

Décharger le dispositif en ouvrant par l'intermédiaire du bouton sélecteur "FLOW" et '%', refermer le dispositif.

Démonter les réducteurs de pression, en les conservant dans un lieu protégé et propre. (Voir l'installation)

La recharge, la vérification et le contrôle périodique des bouteilles doivent être effectués par des sociétés spécialisées conformément aux réglementations en vigueur dans le pays d'utilisation.

8.2**NETTOYAGE**

Utiliser des détergents non agressifs pour le plastique

Nettoyer les surfaces du dispositif avec un chiffon sec.

Avant et après l'utilisation nettoyer, déterger ou stériliser les parties en contact avec le patient ou avec sa respiration.



Nettoyer le Plexiglass® de protection des débitmètres avec un détergent antistatique

Tableau du nettoyage des composants MASTER FLUX PLUS

FIG/POS	MATERIAU	CODE	DESCRIPTION	STERILISATION A VAPEUR	NOMBRE DE CYCLES DE STÉRILISATION
3 / F	Néoprène	3MEDN0002	BALLON EN CAOUTCHOUC	NO	-



Pour le nettoyage du masque (parties en silicone et coque), se reporter au manuel d'utilisation "Circuits et masques".



LES ARTICLES INCLUS VARIANT SELON LA CONFIGURATION



Vérifier l'intégrité des composants avant chaque utilisation.



Si le MASTER FLUX PLUS reste à l'arrêt pour une durée supérieure à un mois, effectuer un contrôle fonctionnel.

Le dispositif MASTER FLUX PLUS plus est équipé de dispositifs de sécurité qui régissent la bonne maîtrise de l'appareil, mais il est recommandé de vérifier périodiquement le fonctionnement de l'appareil en effectuant les vérifications de routine suivantes.

8.2.1 Contrôle de fonctionnement: Vérifier le fonctionnement en conformité avec les instructions décrites dans la section "7.1 Instructions pour l'utilisation".

8.2.2 Vérifier les flotteur à l'intérieur des débitmètres: ils doivent tourner sur eux-mêmes et se déplacer librement dans le cône de mesure, lors du réglage des débits. Assurez-vous également que les valeurs ajustées sont stables.

8.2.3 Contrôle du bouton FLUSH: presser et vérifier que le flotteur de la colonne N2O tombe à 0 (zéro) tandis que l'oxygène a un débit maximal. Relâchez le bouton flush O2 vérifier que l'alimentation en O2 est interrompue.

8.2.4 Contrôle du bloc de N2O: Définir une livraison avec une concentration de 50%, fermer le réservoir d'oxygène (simulant la situation de cylindre terminé) et assurez-vous que, après quelques secondes, il y a un bloc complet de approvisionnement de N2O.

8.2.5 Vérifier les fuites: Fermer le bouton sélecteur "FLOW" (A – figure 9). Ouvrir les soupapes des bouteilles d'Oxygène et de Protoxyde et relever les valeurs indiquées par les manomètres. Fermer les soupapes des bouteilles. Laisser passer ~ 5 minutes et relever les nouvelles valeurs indiquées par les manomètres. Si les valeurs coïncident le dispositif n'a pas de fuites.



Utiliser exclusivement des pièces de rechange et des accessoires originaux



REDUCTEURS DE PRESSION

SUIVRE LES INDICATIONS REPORTEES SUR LES MANUELS DES DISPOSITIFS.



MASQUES ET CIRCUIT COMPLET

SUIVRE LES INDICATIONS FOURNIES DANS LE MANUEL DU CIRCUIT ET DES MASQUES.

SITUATIONS QUI PEUVENT ETRE VERIFIEES LORS DU FONCTIONNEMENT:

Problèmes	Causes possibles	Remède
Ne distribue pas d'oxygène	Bouteille déchargée	Charger la bouteille
	Réducteur de pression non fonctionnel	Remplacer le réducteur
	Problèmes internes du boîtier débitmétrique	Contrôle du dispositif chez Tecno-gaz
Ne distribue pas de protoxyde d'azote	Absence d'oxygène	Charger la bouteille
	Réducteur de pression non fonctionnel	Remplacer le réducteur
Indicateur de protoxyde orienté vers la partie supérieure	Manœuvre erronée	Remettre à zéro le bouton sélecteur 'FLOW' Rétablir le fonctionnement correct
	Problème intérieur	Contrôle du dispositif chez Tecno-gaz

10 PROCEDURES POUR LE SERVICE ET L'ASSISTANCE

En cas de défaillance ou de révision contacter directement l'assistance après-vente téléphonique:

TECNO –GAZ S.p.A.

Strada Cavalli 4, 43038, Sala Baganza, Parma, ITALIA.

www.tecnogaz.com

PHONE	+39 0521 8380
FAX	+39 0521 833391
@	cme2@tecnogaz.com

Ce sera le service d'assistance après-vente à évaluer l'opportunité du retour à l'usine ou bien de l'intervention d'un technicien et, après avoir inspecté l'appareillage, ce sera le service à rédiger un devis des frais et dépenses qui sera envoyé au client distributeur qui, à son tour, va le remettre au client final, pour signature et approbation.

Après avoir reçu le devis signé et approuvé, l'intervention de réparation sur le dispositif sera démarrée.

Le dispositif sera envoyée dans les temps indiqués sur le devis.

Au cas où il serait nécessaire d'envoyer le dispositif, s'en tenir aux indications obligatoires dont ci-dessous:

- Utiliser l'emballage d'origine; si non disponible, utiliser un emballage adéquat. La marchandise voyage aux risques et périls de l'expéditeur.
- Expédier uniquement le boîtier flux métrique et les réducteurs de pression, insérés séparément dans un film cellophane propre
Les réducteurs ne doivent pas être contaminés (détergents, alcool, huiles...) si l'assistance considère que l'emballage n'est pas conforme, les réducteurs seront mis à la casse.
- Indiquer par écrit et insérer dans l'emballage un document indiquant avec précision l'anomalie détectée ou bien le service d'assistance que l'on demande.
- Envoyer toujours franco de port; dans le cas contraire les frais de port soutenus seront à la charge du client.

Tous les emballages non d'origine qui nous parviendront seront écoulés.

La machine sera renvoyée dans l'emballage d'origine (le coût de l'emballage sera à la charge du client) en utilisant le transporteur du client.

INHALTSVERZEICHNIS

- 1. EINSATZ UND VERWENDUNGSZIEL**
- 2. SICHERHEIT**
 - 2.1 SICHERHEITSMARKIERUNG
 - 2.2 SICHERHEITSVORRICHTUNGEN
 - 2.3 HANDHABUNG
 - 2.4 ENTSORGUNG
- 3. TECHNISCHE DATEN**
- 4. AUSPACKEN**
- 5. BESCHREIBUNG DER BESTANDTEILE**
 - 5.1 LISTE DER GELIEFERTEN KOMPONENTEN
 - 5.2 KOMPONENTEN MOBILE VERSION
 - 5.3 KOMPONENTEN WANDVERSION
 - 5.4 BENUTZEROBERFLÄCHE
 - 5.5 MASKEN
 - 5.6 MASKENMASSNAHMEN
 - 5.7 MASKENKREIS
- 6. INSTALLATION**
 - 6.1 INSTALLATION MASTER FLUX PLUS MOBIL
 - 6.2 INSTALLATION MASTER FLUX PLUS WANDAUSFÜHRUNG
 - 6.3 ANSCHLUSS DER LEITUNGEN UND DES ZUBEHÖRS
 - 6.4 ABFÜHRUNG AUSGEATMETER GASE
 - 6.4.1 DIREKTER ANSCHLUSS AUSSEN AN DER PRAXIS
 - 6.4.2 ANSCHLUSS EN DIE CHIRURGISCHE ABSAUGVORRICHTUNG
- 7. BETRIEB DES GERÄTS**
 - 7.1 STEUERBRETT
 - 7.2 GEBRAUCHSANLEITUNG
 - 7.3 REANIMATION MIT MASTER FLUX PLUS
- 8. WARTUNG**
 - 8.1 AUSTAUSCH DER GASFLASCHEN
 - 8.1 REINIGUNG
 - 8.2 PROGRAMMIERTE WARTUNG
- 9. SIGNALE**
- 10. KUNDENDIENSTVERFAHREN**

VERWENDUNGS-ZIEL

MASTER FLUX PLUS ist ein Gerät für die Eingabe von einer Mischung von Sauerstoff und Lachgas, das wird für Lachgassedierung bzw. Sedieranalgesia.

ANWENDUNG

Die Konzentrationswerte der verabreichten Mischung sind wie folgt:

O₂ ≥ 30%

N₂O ≤ 70%

Die Verabreichung erfolgt mit einer Nasenmaske, der Patient muss die Mischung durch aktives Atmen aus der Nase inhalieren.

Die Wachnarkose ist angezeigt für alle Patienten der Zahnarztpraxis, Erwachsene und Kinder.

Die Wachnarkose ermöglicht den Patienten, sich Zahnbehandlungen zu unterziehen und dabei die Angst und den Beklemmungszustand zu begrenzen, die alle Patienten empfinden, wenn sie eine Zahnarztpraxis betreten.



UNGEIGNET IN SCHWANGERSCHAFT, BEI DROGENABHÄNGIGEN PATIENTEN ODER PATIENTEN MIT SCHWEREN LUNGENENTZÜNDUNGEN UND BEI MENSCHEN MIT SCHWEREN GEISTESKRANKHEITEN.



MASTER FLUX PLUS darf nur durch ärztliches Personal benutzt werden, das eine spezifische Schulung erhalten hat.



Gerät nicht zur Verabreichung von Vollnarkosen oder als Teil oder in Kombination mit einem allgemeinen Narkosesystem benutzen.



Per Gesetz ist der Verkauf dieses Geräts auf Ärzte und Zahnärzte beschränkt.

ACHTUNG



Nicht versuchen, dieses Gerät zu reparieren, modifizieren oder kalibrieren. Die nicht autorisierte Reparatur, die Modifikation oder der Missbrauch dieses Geräts wirken sich negativ auf die Leistungen aus und machen die Garantie ungültig.



Vor jedem Gebrauch ist zu sicherzustellen, dass die Speisegasanschlüsse ordnungsgemäß hergestellt sind.



Das Gerät dient ausschließlich zur Verabreichung von Medikamenten für die Technik der Wachnarkose.



Die Gegenanzeigen in Bezug auf die Verwendung dieses Medikaments sind in dem Sicherheitsdatenblatt und der mit dem Medikament mitgelieferten Dokumentation angeführt. Sollten diese Dokumente nicht vorhanden sein, den Gaslieferanten kontaktieren.



Entfernen Sie nicht das Schild



Ersetzen Sie die mitgelieferten Getriebe nicht durch andere, die nicht vom Hersteller geliefert wurden

2

SICHERHEIT

Die Verwendung des PULSOXIMETERS muss routinemäßig im Zuge der Wachnarkose erfolgen.

Bedeutung der ermittelten Werte:



Sättigungsniveau von O ₂	Hypoxie-Grad
≥ 95%	Keine Hypoxie
90-94%	Leichte Hypoxie
85-89%	Mäßige Hypoxie
84%	Schwere Hypoxie

2.1 Sicherheitsmarkierung

Das Gerät erfüllt die Richtlinie 93/42 EWG inkl. Änderungen und Ergänzungen.
Die Konformitätserklärung ist dem Gerät beigelegt

2.2 Sicherheitsvorrichtungen

Das Gerät wird mit Sicherheitsvorrichtungen geliefert:

- Wenn der Sauerstoffdruck (O₂) sinkt, wird Lachgaszufuhr (N₂O) automatisch unterbrochen.
- Ein integriertes Mischsystem reguliert das N₂O dermaßen, dass in der Gasmischung immer eine Mindestmenge an O₂ von mindestens 30% vorhanden ist.
- Wenn der Fluss der Gasmischung unterbrochen wird, atmet der Patient Luft von außen über ein spezielles Sicherheitsventil.
- Sollte der Fluss seine Richtung wechseln und zum Gerät zurückströmen, schützt ein Rückschlagventil den Patienten vor dem erneuten Einatmen der ausgeatmeten Gase und vor Ansammlungen von Kohlendioxid (CO₂).
- Der Knopf zum Einstellen der Flussrate kontrolliert die Gesamtflussrate, er regelt automatisch die Sauerstoff- und Lachgasanteil in der eingestellten Konzentration.
- Mit der Taste 'FLUSH' können große Mengen reinen Sauerstoffs ausgegeben werden.

**WARNHINWEISE & NÜTZLICHE KENNTNISSE**

WÄHREND DER GASEINREICHUNG MUSS DER PATIENT STÄNDIG ÜBERWACHT WERDEN, DIE FLUSSRATEN VON SAUERSTOFF UND STICKOXIDUL MÜSSEN UNTER KONTROLLE GEHALTEN WERDEN, INDEM DIE WERTE AN DEN SÄULEN UND DER KONTROLLBEUTEL ÜBERWACHT WERDEN.

2.3 Handhabung



Um das Gerät Master Flux Plus zu bewegen, ausschließlich die mitgelieferten Griffe verwenden.



Figura 1

	<p>Das Gerät nicht ohne Verwendung der Griffe schieben.</p>
	<p>Nicht auf das Gerät setzen und keine Gewichte darauf ablegen.</p>
	<p>Bevor das Gerät bewegt wird, die Maske und die Schläuche vorsichtig in den entsprechenden Befestigungssystemen positionieren, um ein Stolpern oder Brüche zu vermeiden.</p>

2.4 Entsorgung

Die Entsorgung der Verpackung, des Gerätes und der einzelnen Komponenten muss den im Verwendungsland geltenden Vorschriften für die Behandlung und Beseitigung potenziell biokontaminierender Abfälle entsprechen.

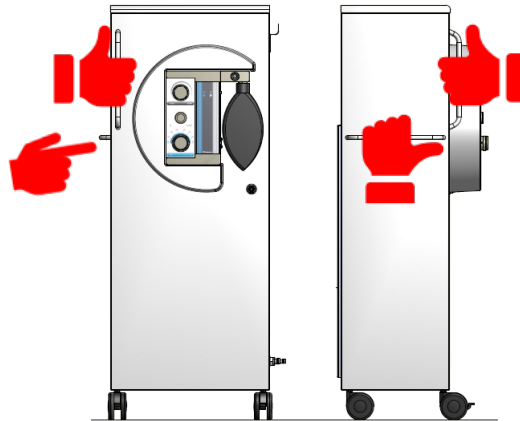
Verpackungsmaterial bitte sachgerecht entsorgen.

Das Gerät enthält keine elektrische bzw. elektronischen Teile und Batterien.

3

TECHNISCHE DATEN

VERSORGUNG

Versorgungsdruck	3.5 bar \cong 50 PSI (max. 6 bar \cong 87 PSI)
Maximale Durchflussmenge	10 l/min (Liter pro Minute)

GEWICHTE MASTER FLUX PLUS MOBIL:

Gewicht ohne Gasflaschen	46 kg
Gewicht mit 5-Liter-Gasflaschen	180 kg (leere Gasflaschen)
Gewicht mit 10-Liter-Gasflaschen:	45 kg (leere Gasflaschen)

GASFLASCHEN FÜR MASTER FLUX PLUS MOBIL:

Maximale Traglast Gasflaschenfach Räderebene	950 mm
Maximale Traglast oberes Gasflaschenfach	140 mm

GEWICHTE MASTER FLUX PLUS WANDAUSFÜHRUNG:

Gewicht der Steuereinheit	6,3 kg
---------------------------	--------

FLUSSIMETRO

Wiederholbarkeit	+/-10% der angeführten Durchflussmenge
------------------	--

Der Durchfluss wird folglich an der flachen Oberkante des Schwimmers gemessen, wodurch Parallaxefehler vermieden werden.

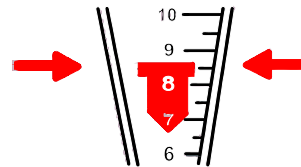

VERBRAUCH:

Das folgende Verbrauchsbeispiel ist als theoretischer Anhaltspunkt zu verstehen.

10-LITER-FLASCHE MEDIZINISCHER SAUERSTOFF
GEFÜLLT MIT 200 BAR DRUCK

VERFÜGBARES VOLUMEN	2000 Liter Gas
---------------------	----------------

10-LITER-FLASCHE STICKOXIDUL
GEFÜLLT MIT 7 KG FLÜSSIGGAS

VERFÜGBARES VOLUMEN	4600 Liter Gas
---------------------	----------------

BEI EINSTELLUNG VON:

AUSGABE	10 NI/min
---------	-----------

MISCHUNG	50 %
----------	------

AUTONOMIE:

SAUERSTOFF	400 min
------------	---------

STICKOXIDUL	950 min
-------------	---------



Basierend auf dem durchschnittlichen Gasverbrauch empfiehlt TECNO-GAZ alle 2 Sauerstoff-Flaschen den Austausch der Stickstoff-Protoxid-Flasche.



Bild A



Bild B

04

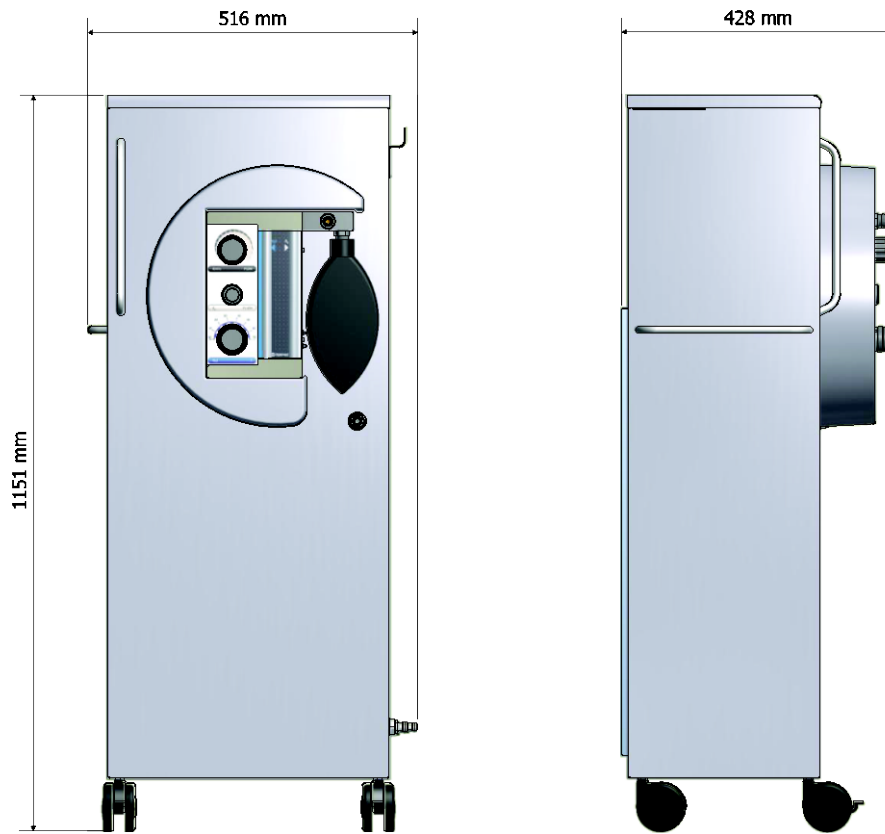
AUSPACKEN

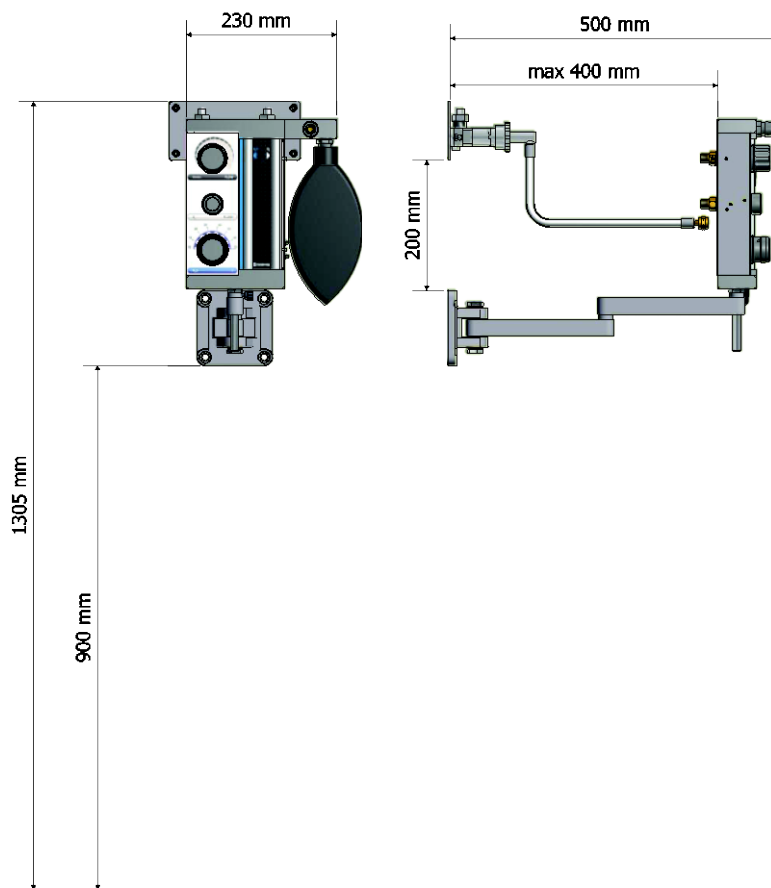

DIE MASTER FLUX PLUS SCHRÄNKE DÜRFEN NICHT GESTAPELT WERDEN



Die Verpackung darf nicht gestoßen werden, muss sorgfältig gehandhabt und darf nicht gerollt oder fallen gelassen werden.



Keine Geräte mit offensichtlichen, durch den Transport bedingten Schäden verwenden.



Die Verpackung entfernen und den Gerätezustand kontrollieren.



Die Verpackung muss über die gesamte Garantiezeit aufbewahrt werden. Der Hersteller akzeptiert keine Rückgaben ohne Original-Verpackung.



Die verpackten Geräte müssen trocken und bei Temperaturen zwischen +5 und +40 °C gelagert werden.

05

BESCHREIBUNG DER BESTANDTEILE

5.1

Liste der gelieferten Komponenten

ARTIKEL	MF010ZMF Master Flux Plus mit Wandausführung mit Sauerstoff- Anschlüssen AFNOR und Stickoxidul- Anschlüssen UNI	1601ASD Master Flux Plus Wandausführung mit Druckminderern mit Sauerstoff- und Stickoxidul- Anschlüssen DIN	1601AS Master Flux Plus Wandausführung mit Druckminderern mit Sauerstoff- und Stickoxidul- Anschlüssen UNI	MF009ZMF Master Flux Plus Schrankausführung g mit ohne Druckminderer-Set	MF006ZMF Master Flux Plus Schrankausführung g mit Druckminderern mit Sauerstoff- Anschlüssen AFNOR und Stickoxidul- Anschlüssen UNI	1600ASD Master Flux Plus Schrankausführung g mit Druckminderern mit Sauerstoff- und Stickoxidul- Anschlüssen DIN	1600ASF Master Flux Plus Schrankausführung g mit Untersetzungsgetri- eben mit Sauerstoff- und Stickoxidul- Anschlüssen AFNOR	1600AS Master Flux Plus Schrankausführung g mit Druckminderern mit Sauerstoff- und Stickoxidul- Anschlüssen UNI
SCHRANKAUSFÜHRUNG	SMFA301	SMFA301	SMFA301	2ZMFA0020	2ZMFA0020	2ZMFA0020	2ZMFA0020	2ZMFA0020
KIT MASTER	2ZZMFA0065	2ZZMFA0063	2ZZMFA0062	2ZZMFA0057	2ZMFA0059	2ZZMFA0058	2ZZMFA0061	2ZMFA0060
DRUCKMINDE RER N₂O	SMFA360	SMFA360	SMFA360		MF011ZMF	MF011ZMF	MK005ZMF	MF011ZMF
DRUCKMINDE RER O₂	SMFA361	SMFA358	MF003ZMF		1513A4F	1513A4D	1513A4F	1513A4
MASKEN	<p>MF820ZMF Master Flux Kreislauf</p> <p>MF824ZMF Ansaugkreislauf Master Flux Plus (new)</p> <p>MF835ZMF Intelliflux 1. Maske komplett Master Flux plus 0-4 Jahre</p> <p>MF836ZMF Intelliflux 2. Maske komplett Master Flux plus 4-10 Jahre</p> <p>MF837ZMF Intelliflux 3. Maske komplett Master Flux plus >10 Jahre</p>							



Bild 2

ABB.	POSITION	ANZAHL	ART.-NR.	BEZEICHNUNG
3	1	1	SMFA144	KUNSTSTOFFABDECKUNG
	2	1	SMFA506	DURCHFLUSSMESSER
	3	3	SMFA223	ABSTANDHALTER
	4	3	CM25021	FLÜGELSCHRAUBE M5
	5	3	3MECQ0010	ABSTANDHALTER
	6	3	CM20015	UNTERLEGSCHIEBE
	7	3	CM25019	FLÜGELMUTTER M6
	9	2	SMFA237	SCHLAUCHTÜLLE GASABFÜHRUNG

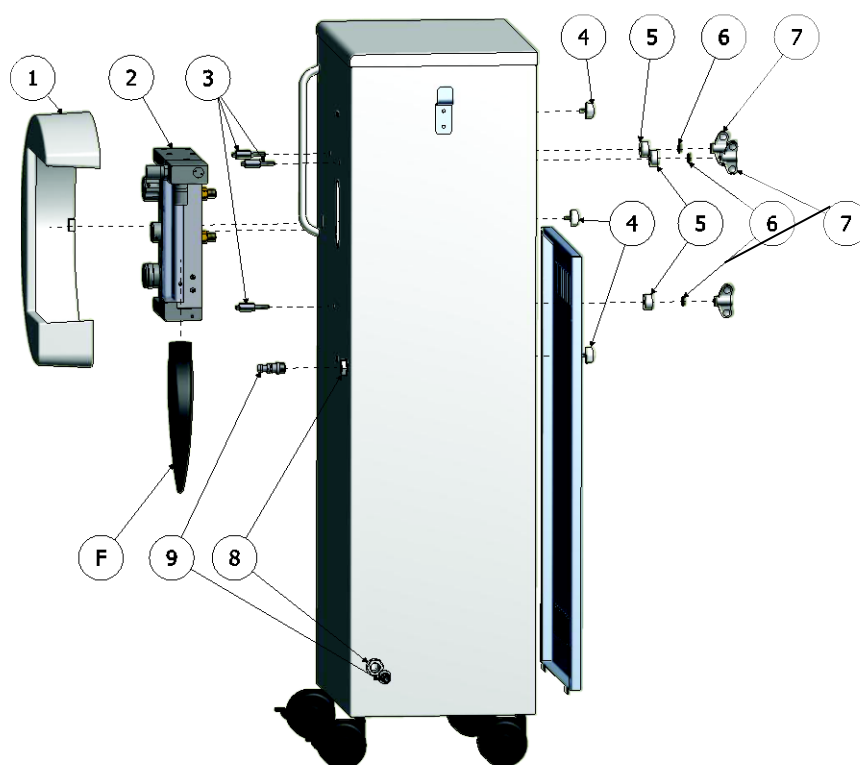

Bild 3 - 4

WANDBEFESTIGUNG (Abbildung 2-4)

ABB.	POSITION	ANZAHL	ART.-NR.	BEZEICHNUNG
4	10	1	SMFA313	ZAPFEN
	11	1	SMFA364	O ₂ ROHR
	12	1	SMFA365	N ₂ O ROHR
	13	1	SMFA301	WANDHALTERUNG
	14	1	SMFA501	WANDPLATTE
	15	1	CM30011	ZAPFEN-SPANNSCHRAUBE

5.4

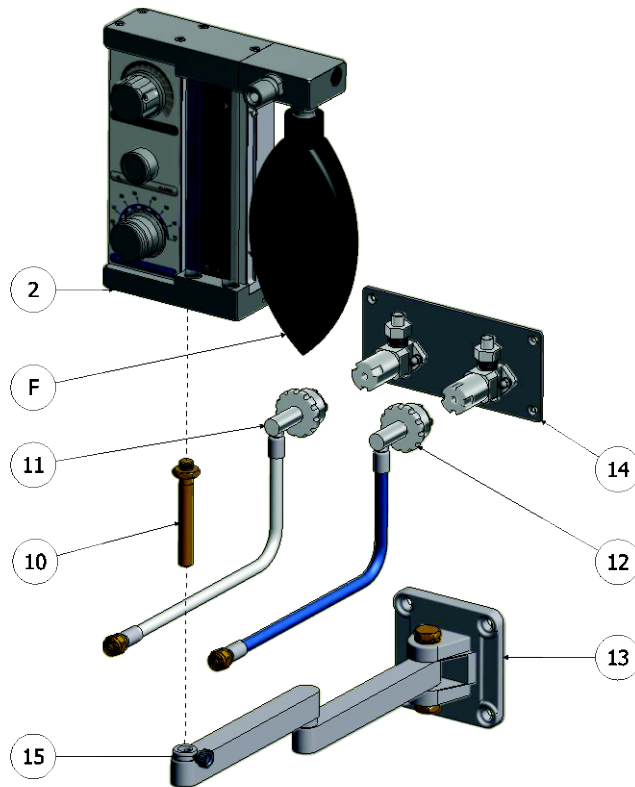
BENUTZEROBERFLÄCHE



Bild 5

A	Reglerknopf FLOW
B	Taste FLUSH
C	Reglerknopf % N ₂ O
D	Durchflussgerät N ₂ O
E	Durchflussgerät O ₂
F	Reservoirbeutel
G	Schlauchverbindung für Maskenanschluss

5.5

MASKEN

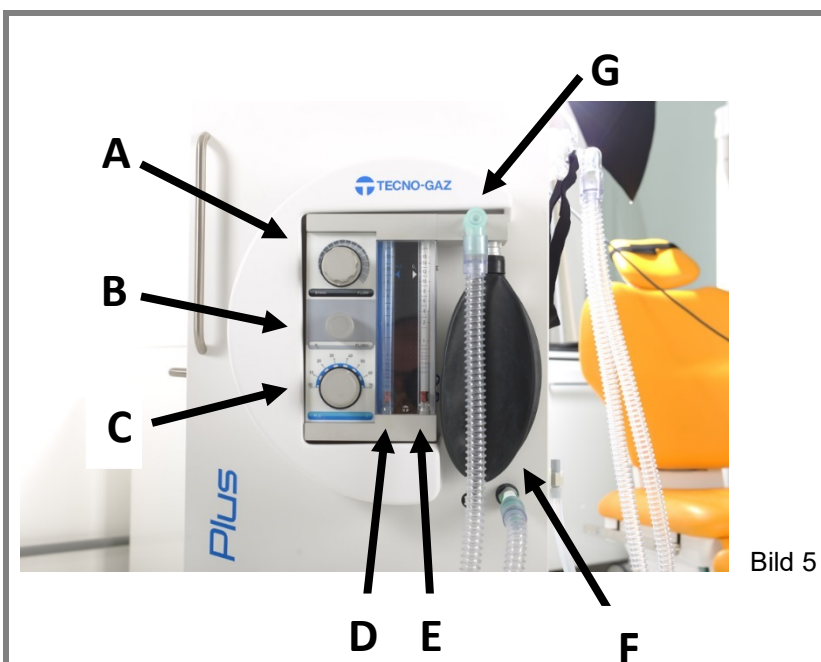

Figura 6

①	Stützfläche für die Stirn des Patienten
②	Gaseinlass mit Rückschlagventil
③	Gasauslass mit Rückschlagventil + Pfeil auf dem PC zur Anzeige der Durchflussrichtung
④	Gummiband im Klettverschluss mit Kunststoffhaken

5.6

MASKENMASSNAHMEN

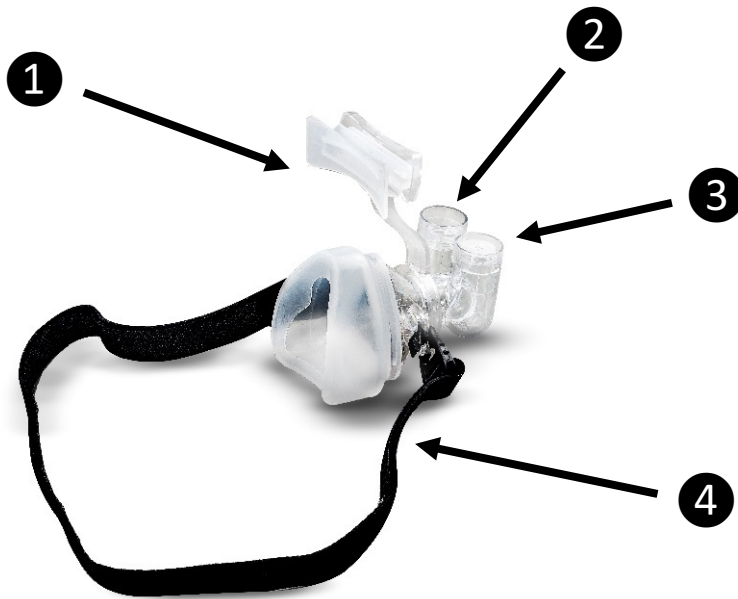
MF835ZMF	MF836ZMF	MF837ZMF	MF838ZMF
MASKEN 1	MASKEN 2	MASKEN 3	MASKEN 4
0-4 Jahre	4-10 Jahre	>10 Jahre	

Bild 7

5.7

MASKENKREIS



Bild 8

VOLLSTÄNDIGER MASCHINENKREIS



Bild 9



Für Teile einzelner Komponenten,
Siehe das Benutzerhandbuch für "Schaltungen und Masken".

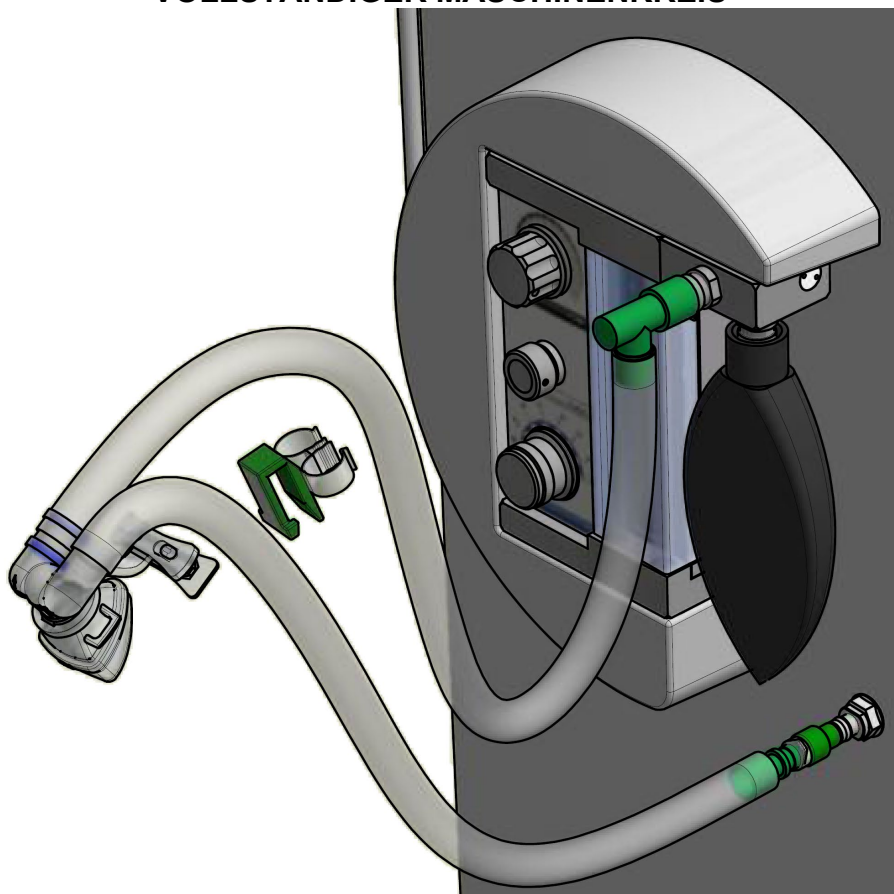

Verpackung entfernen und Zustand des Geräts überprüfen.
Keine Geräte mit offensichtlichen, durch den Transport bedingten Schäden verwenden.

6.1 Installation MASTER FLUX PLUS Mobil

MONTAGE DES DURCHFLUSSMESSERS (Abbildung 3)

siehe beiliegende Kurzanleitung 0ZMFI0007

Abstandhalter aus Stahl **(3)** (3 x) an den Durchflussmesser **(2)** anschrauben.
Schutzkappen von den Versorgungsrippeln des Durchflussmessers entfernen.
Durchflussmesser an den Schrank montieren, dazu die Abstandhalter aus Stahl **(3)** in die entsprechenden Bohrungen im Schrank einsetzen und mit den mitgelieferten 3 Abstandhaltern aus Kunststoff **(5)**, 3 Unterlegscheiben **(6)** und drei Flügelmutter **(7)** am Schrank befestigen.

MONTAGE DES FRONTCOVERS (Abbildung 2 Pos 1)

siehe beiliegende Kurzanleitung 0ZMFI0007

Kunststoff-Cover an den drei Bohrungen am Schrank positionieren.
Kunststoff-Cover mit den drei mitgelieferten Flügelschrauben **(4)** befestigen.

MONTAGE DER ABLEITUNGSSCHLAUCHTÜLLE (Abbildung 2 Pos 9)

siehe beiliegende Kurzanleitung 0ZMFI0007

Wenn der Schlauch zur Ableitung der ausgeatmeten Gase verwendet wird, die mitgelieferte Schlauchtülle an die Anschlussstücke aus Kunststoff anschrauben.

MONTAGE DER GASFLASCHEN (NICHT MITGELIEFERT) (Abbildung 10)

Druckminderer an den Gasflaschen anbringen (siehe Betriebsanleitung der Druckminderer).
Für **5-Liter**-Flaschen den Zwischenboden **(16)** einsetzen und mit den entsprechenden Halterungen fixieren.

Für **10- und 14-Liter**-Flaschen den Zwischenboden auf dem Boden des Schrankes einstellen.
Die Manometer der Druckminderer **(21)** müssen so angeordnet werden, dass sie vom Anwender einsehbar sind.

Die Flaschen mit dem mitgelieferten Klettband am Schrank befestigen.

Endmutter des Rohrs des **N₂O-Druckminderers (15)** auf den Versorgungsrippel des Durchflussmessers **(17)** (**LINKSGEWINDE**) aufschrauben.

Endmutter des Rohrs des **O₂-Druckminderers (14)** auf den Versorgungsrippel des Durchflussmessers **(18)** (**RECHTSGEWINDE**) aufschrauben.

Rückseitige Tür mit den beiden Magneten an der Oberseite schließen.



Bild 10

ABB.	POSITION	ANZAHL	ART.-NR.	BEZEICHNUNG
6	R1	1	MF847ZMF	GETRIEBE O ₂ (ITA)
	R2	1	MF011ZMF	GETRIEBE N ₂ O (ITA)
	L	1		VENTIL
	M	1		MANOMETER

6.2 Installation MASTER FLUX PLUS Wandausführung

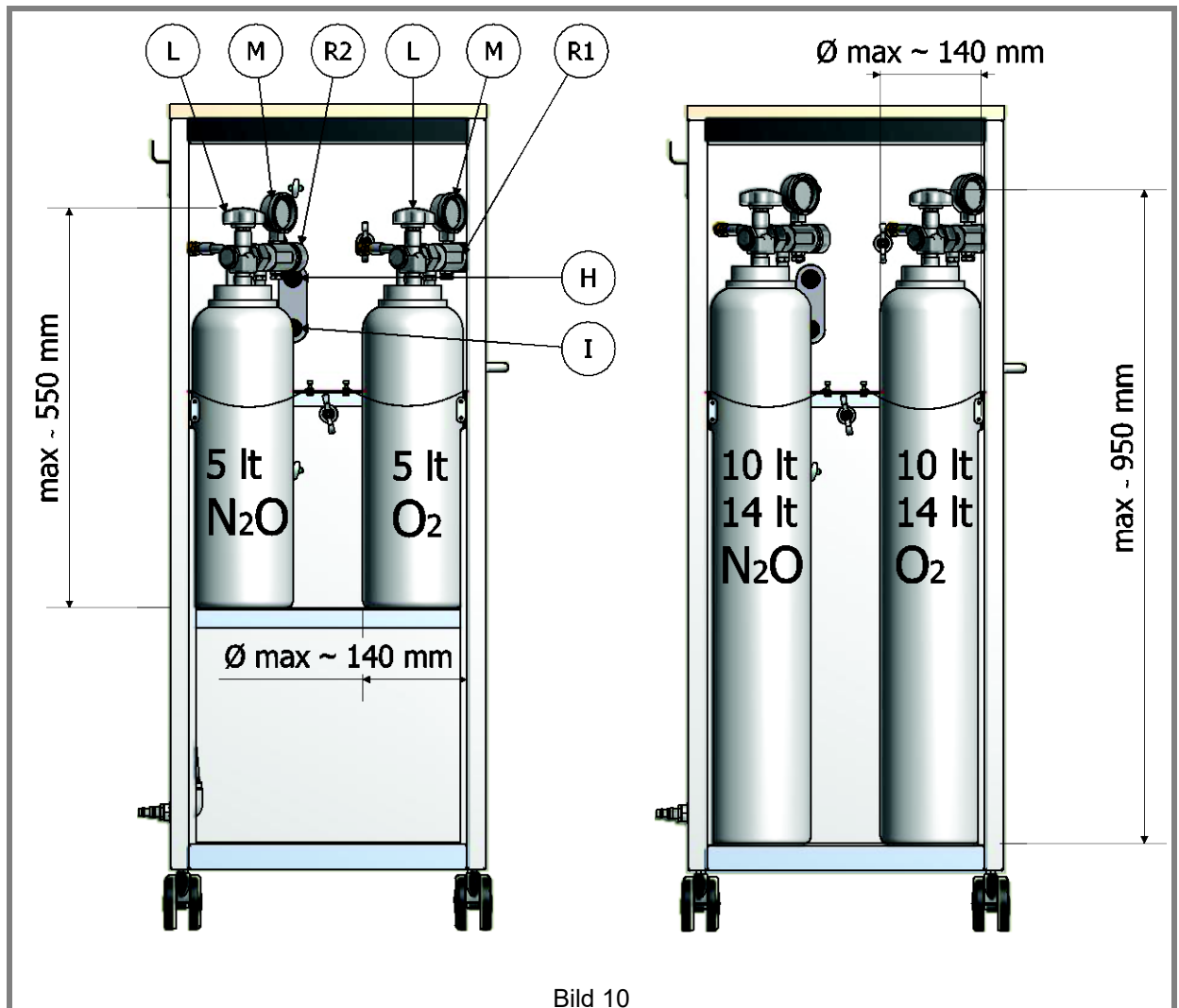

Bild 11



Bild 12

- Abbildung 5, 10
 MASTER FLUX PLUS WANDHALTERUNG (13) mit 4 Wanddübeln Ø14 mm M8 an der Wand fixieren.
 MASTER FLUX PLUS WANDPLATTE (14) mit 4 Wanddübeln Ø 8 (mm) an der Wand befestigen.
 Zapfen (10) an die Basis des Durchflussmessers anschrauben.
 Zapfen in das Endstück der Halterung (15) einsetzen.
 Zapfen mit der entsprechenden Spannschraube (15) an der Halterung fixieren.
 Mutter des O₂-Rohrs (11) mit dem O₂-Versorgungsnippel am Durchflussmesser verbinden (I) (LINKS-Gewinde).
 Mutter des N₂O-Rohrs (12) auf den N₂O-Versorgungsnippel am Durchflussmesser schrauben (H) (RECHTS-Gewinde).
 Freie Enden der Schläuche mit den Wandanschlüssen verbinden (Kupplungen drücken und drehen, um sie in den Anschlüssen einrasten zu lassen).

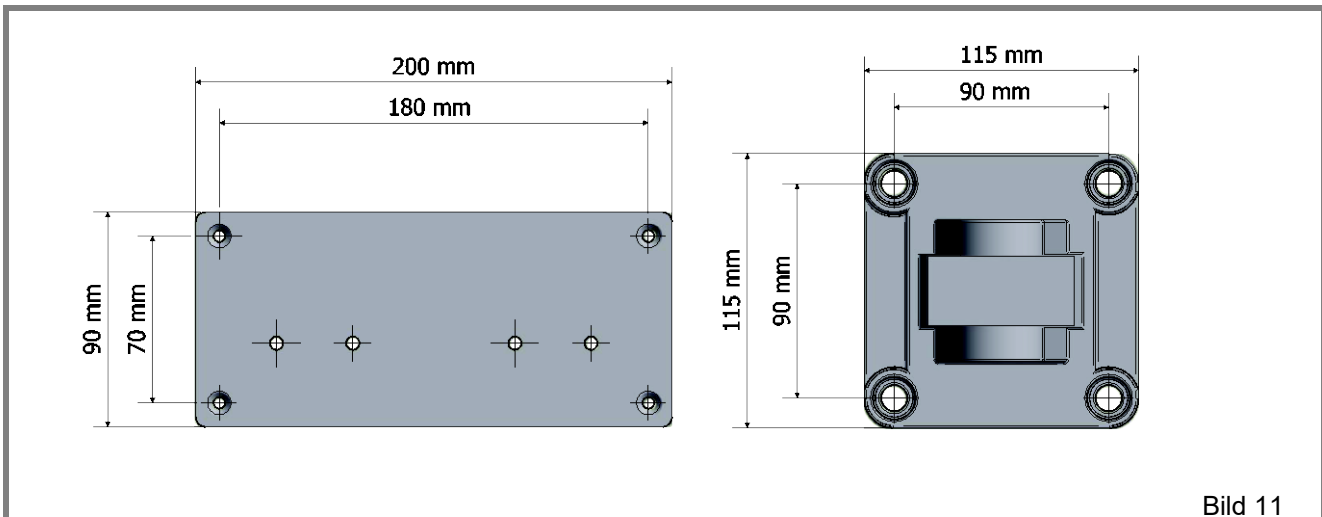
HINWEISE ZUR ZENTRALEN VERSORGUNGSANLAGE



Die Installation muss durch spezialisierte Techniker ausgeführt werden, die zentrale Versorgungsanlage muss den geltenden Richtlinien entsprechen.
Europäische Richtlinie 93/42/EG

Wandanschluss mit den mitgelieferten Anschlussösen mit dem Potentialausgleich der Elektroanlage verbinden.

Die mitgelieferten Druckminderer müssen an die Gasflaschen der zentralen Versorgungsanlage angeschlossen werden.

Der Ausgang des **N₂O**-Druckminderers umfasst einen Schlauch, an dessen Ende ein Anschlussstück mit Außengewinde **1/4" G** für den Anschluss an die Anlage geklammert ist.

Der Ausgang des **O₂**-Druckminderers umfasst einen Schlauch, an dessen Ende ein Anschlussstück mit Außengewinde **1/8" G** für den Anschluss an die Anlage geklammert ist.

Die Befestigungsplatte ist nicht im Lieferumfang enthalten.

6.3 Anschluss Leitungen und Zubehör:



Bild 13

ABB.	POSITION	ANZAHL	ART.-NR.	BEZEICHNUNG
8	A	1		REGLERKNOPF ' FLOW '
	B	1		TASTE ' FLUSH '
	C	1		REGLERKNOPF ' % N2O '
	D	1		N2O-DURCHFLUSS-ANZEIGER
	E	1		O2-DURCHFLUSS-ANZEIGER
	F	1	3MEDN0002	GUMMI-BEUTEL
	G	1		SCHLAUCHTÜLLE MASKENANSSCHLUSS
	H	1		N2O-NIPPEL
	I	1		O2-NIPPEL

Gummi-Beutel (**F**) an den Durchflussmesser anschließen, dazu den Beutel fest auf die entsprechende Schlauchtülle schieben.

Die Maskensätze werden über die Schlauchtülle (**G**) mit dem Gerät verbunden.

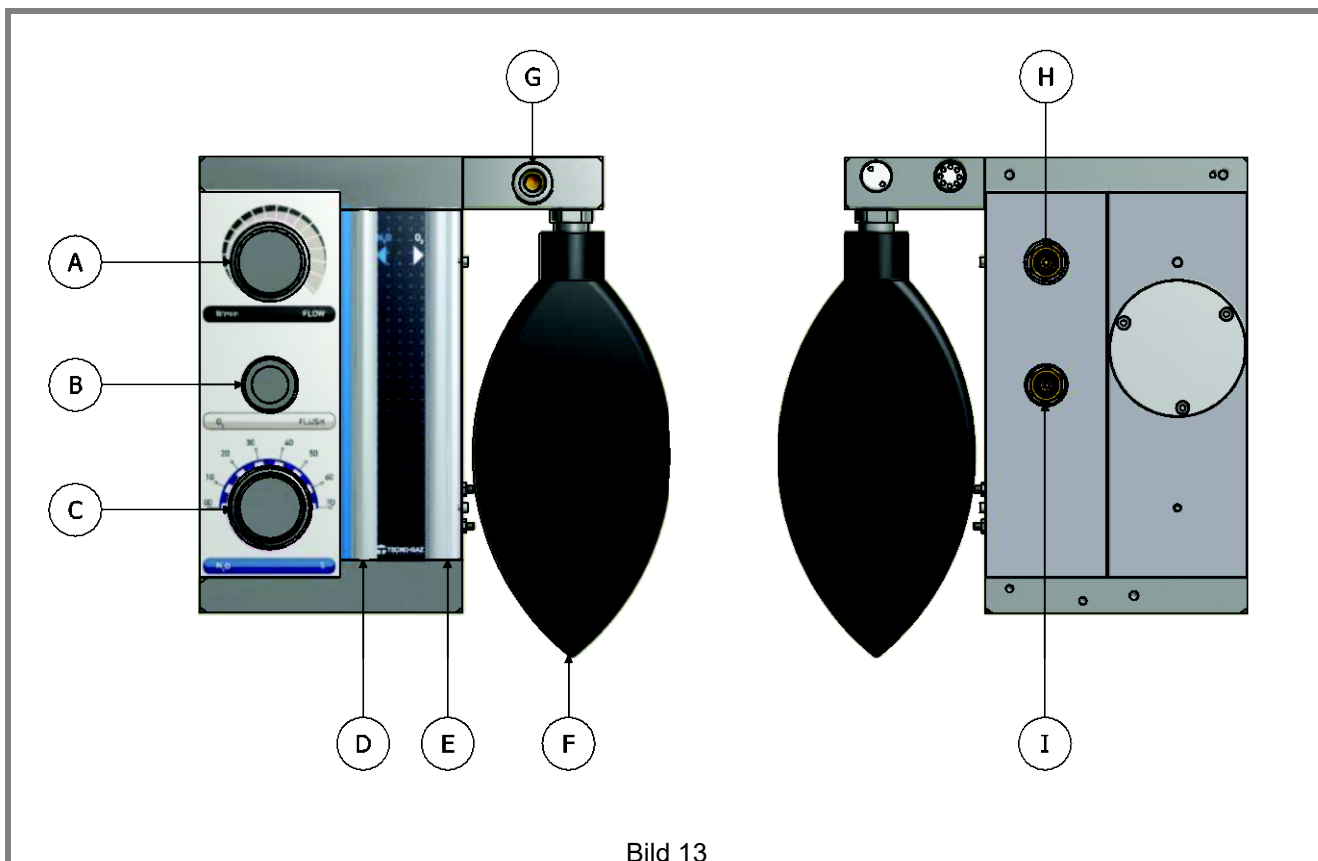
Der Gasabfluss-Schlauch wird je nach Art der verwendeten Gasableitung auf unterschiedliche Weise angeschlossen (**siehe 6.4 – Gasentleerung**).

6.4 Abführung ausgeatmeter Gase:

Zur Sicherheit des Arbeitsraums und des Personals müssen die ausgeatmeten Gase nach außerhalb des Arbeitsraums geleitet werden.

Für die Ableitung der Gase nach außen gibt es zwei Möglichkeiten:

- Direkte Verbindung nach außen
- Anschluss an die chirurgische Absaugvorrichtung.

Unbedingt zu beurteilen sind:

- Die Eignung der Absaugvorrichtung zur Ableitung der Gase (**N₂O und O₂**)
- Der Auslass der Absaugvorrichtung muss nach außen gehen und belüftet sein.

Sicherstellen, dass die im Anwendungsland geltenden Vorschriften eingehalten werden.

6.4.1 DIREKTER ANSCHLUSS AUSSEN AN DER PRAXIS

Die Schlauchverbindungen (Abb. 2 Pos 8/9) am Schrank anbringen.

Das mitgelieferte Ventil beseitigen.

Die Leitung, Gasablass des Maskenkreislaufs, an der Schlauchverbindung anschließen (Abbildung 15).

Den Spiralschlauch, Gasauslass (Abbildung 14), an den Schlauchanschluss des Schrankes anschließen.

Das Ende des Spiralrohres auf der Außenseite anbringen und das Vorhandensein des Endfilters sicherstellen (Abbildung 14 Pos 34).

MASTER FLUX PLUS WANDAUSFÜHRUNG

Die Leitung, Gasablass des Maskenkreislaufs, an der Schlauchverbindung anschließen (Abbildung 14 Pos 36).

Das Ende des Spiralrohres auf der Außenseite anbringen und das Vorhandensein des Endfilters sicherstellen (Abbildung 14 Pos 34).



ABB.	POSITION	ANZAHL	ART.-NR.	BEZEICHNUNG
9	34	1	SMFA197	FILTER - SMFA260
	35	1		SCHLAUCH – SMFA199
	36	1		ANSCHLUSSSTÜCK – SMFA257



Bild 15

6.4.2 ANSCHLUSS EN DIE CHIRURGISCHE ABSAUGVORRICHTUNG**MASTER FLUX PLUS SCHRANKAUSFÜHRUNG**

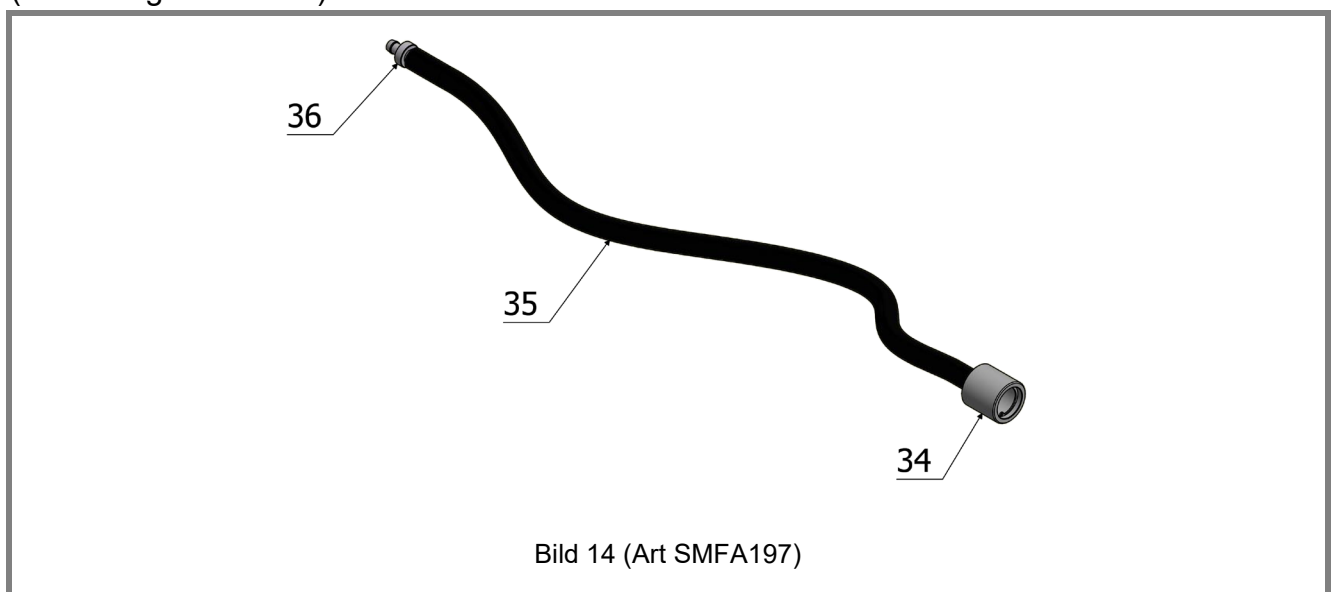
Die Schlauchverbindungen (Abb. 2 Pos 8/9) am Schrank anbringen.

Gasabfluss-Schlauch des Maskenkreises mit dem mitgelieferten Anschlussstück verbinden.

Den Saugkreis (Abbildung 16) an der Schlauchverbindung des Schrankes anschließen.

Anschlussstück mit dem Schlauch der chirurgischen Absaugvorrichtung verbinden (Ø11 mm).

MASTER FLUX PLUS WANDAUSFÜHRUNG

Die Leitung entfernen (Abbildung 16 Pos 43)

Die Leitung, Gasablass des Maskenkreislaufs, am Ventil anschließen (Abbildung 16 Pos 44).

Das Ventil an das chirurgische Sauggerät anschließen (Ø11).

Ventileinstellung

Gelochten Schraubring des Ventils so drehen, dass die Löcher geschlossen sind (Abbildung 16 Pos 44).

Ausgabe der Gase starten, dazu ~10 l/min einstellen.

Chirurgische Absaugvorrichtung starten, dabei die minimale Saugstärke einstellen.

Beutel (Abbildung 13 Pos F) beobachten.

Gelochten Schraubring des Ventils drehen, um die Löcher allmählich zu öffnen, bis der Beutel den Idealzustand „HALB VOLL – HALB LEER“ erreicht.

ACHTUNG

Werden die Ausgabeflussraten verändert, kann es nötig sein, die Absaugraten der ausgeatmeten Gase wieder richtig einzustellen.



Bild 16 (Art MF824ZMF)

ABB.	POSITION	ANZAHL	BEZEICHNUNG
9A	41	1	REDUZIERSTÜCK
	42	1	ENDTEIL
	43	2	ROHRE
	44	1	VENTIL

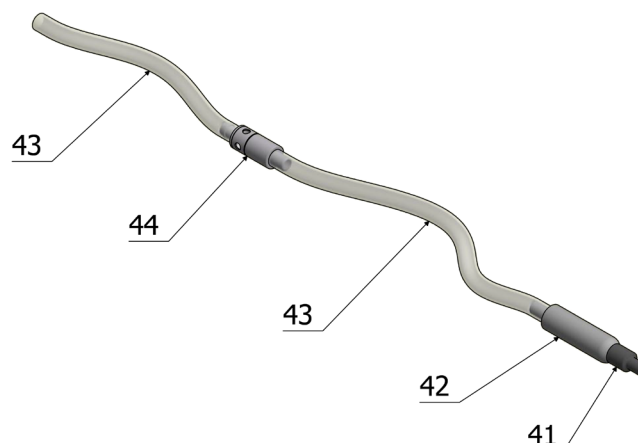

Bild 17

7

BETRIEB DES GERÄTS

7.1 Steuerbrett



Bild 18

BEDIENTASTEN (BILD A10)





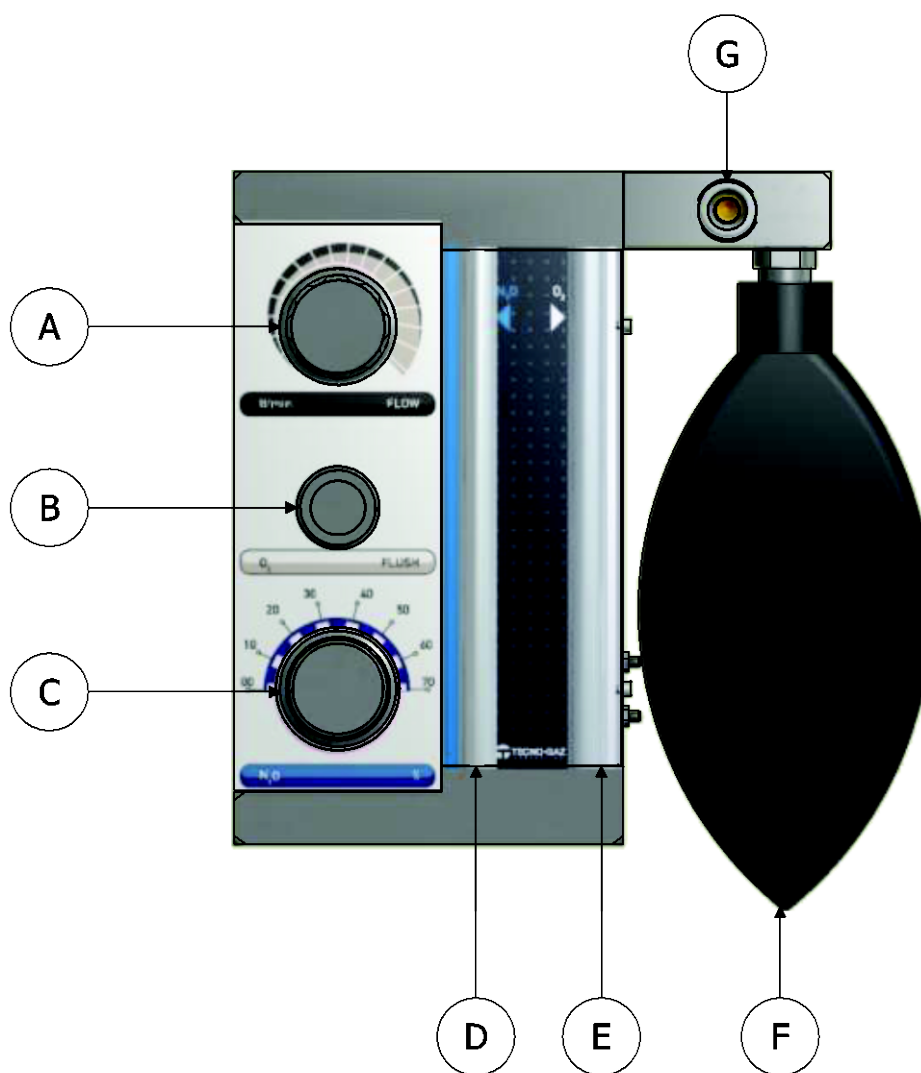

A	REGELUNG DER AUSGABERATE
B	REGELUNG %-ANTEIL STICKOXIDUL
C	NOTFALL-TASTE

KONTROLLELEMENTE



E	FLUSSRATE REINES STICKOXIDUL
D	FLUSSRATE REINER SAUERSTOFF
F	BEUTEL (PRÜFUNG, OB FLUSSRATE FÜR PATIENTEN GEEIGNET)

Bevor das MASTER FLUX PLUS Gerät in der mobilen Ausführung benutzt wird, sind die Räder zu blockieren, die mit Bremse versehen sind, indem die entsprechenden Zungen nach unten gedrückt werden.

Wenn es notwendig ist, das Gerät zu bewegen (z. B. von einem Raum in einen anderen), die Räder entriegeln und das Gerät vorsichtig mit den Griffen (siehe Abschnitt 2.3) schieben.

	Stöße und plötzliche Bewegungen, die zu Stürzen führen könnten, vermeiden.
	Den Masterflux nur auf nicht geneigten und glatten Oberflächen ablegen und bewegen.
	Die Stabilität der Gasflaschen und ihre korrekte Befestigung prüfen.
	Vor dem Handling des Geräts die Gasflaschen schließen.
	Das Gerät nicht an den Griffen hochheben.
	Das Gerät nicht an den Griffen ziehen.
	Die Bedienelemente keinen versehentlichen Stößen aussetzen.

Während des Gebrauchs von MASTER FLUX PLUS in der Wandausführung kann der Durchflussmesser nach Belieben bewegt und ausgerichtet werden, dazu das Gerät am entsprechenden Griff anfassen.

	NICHT AUF DEM DURCHFLUSSMESSER ABSTÜTZEN UND KEINE GEGENSTÄNDE DARAUF ABLEGEN (SOWOHL BEI DER MOBILEN ALS AUCH BEI DER WANDAUSFÜHRUNG). GELENKARM DER WANDAUSFÜHRUNG NICHT MIT GEWALT BEWEGEN.
	VENTILE DER O₂- UND N₂O-FLASCHEN LANGSAM AUFDREHEN (HÄHNEN GEGEN DEN UHRZEIGERSINN DREHEN).

Druck an den Manometern der Druckminderer ablesen (siehe TECHNISCHE DATEN), um die Autonomie der Sauerstoffflasche abzuschätzen. Überprüfen Sie, dass der Beutel und die Schläuche sicher in ihre Anschlüsse eingesetzt sind.



Für den Patienten geeignete Maske wählen.

Maske positionieren, sie muss an der Kontur der Nase des Patienten anliegen.

Maske mit dem schiebbaren Schlauchhalter hinter der Kopfstütze des Stuhls fixieren.

Sicherstellen, dass die Schläuche des Maskenkreises nicht geknickt oder eingeschnürt werden. Der Anwender muss seine Position so wählen, dass er Sichtkontrolle hat über:

- **Gummi-Beutel** (Bild 18 Pos. F)
- **Durchflussgeräte** (Bild 18 Pos. D, E)

	Während der Behandlung sind die an den Säulen (E, D - Abbildung 13) angezeigten Flussraten ständig unter Kontrolle zu halten.
	Bevor der Patient auch nur für kurze Zeit allein gelassen wird, ist die Narkose zu unterbrechen.

Überprüfen Sie, ob der Zeiger des Reglerknopfs (Bild 18 Pos C) %N₂O auf 0 zeigt.

Durch den Knopf FLOW (A) verabreichen Sie 30 Sekunden lang eine Flussrate von 3 l/min Sauerstoff.

BITTEN SIE DEM PATIENTEN, DURCH DIE NASE EIN- UND AUSZUATMEN.

Mit dem Regler **FLOW** die Flussrate einstellen.

Flussrate allmählich verändern, Zustand des Beutels (Bild 18 Pos F) beurteilen, er muss eine Form annehmen, die wir als **halb voll – halb leer** definieren.

Patienten mindestens eine Minute lang atmen lassen, bevor die Flussrate beurteilt wird.

Nach Bestimmung der idealen Flussrate, die durch das Lungenvolumen des Patienten gegeben ist, das Ventil zur Gasabführung wie in Abschnitt 6.4 Abführung ausgeatmeter Gase angeben einstellen.

Mit dem Knopf % (Bild 18 Pos C) kann man den Lachgasanteil verändert

Die Durchflussmessgeräte zeigen die Liter/Minute des gelieferten Stickoxiduls und Sauerstoffs an.

Die Summe der beiden Flussraten entspricht dem am Anfang entsprechend der Atemkapazität des Patienten eingestellten Wert.



Die folgenden Angaben sind Beispiele für die Verabreichung.

Jeder Benutzer sollte den Durchfluss und den Prozentsatz entsprechend dem Patienten einstellen, dem das Medikament verabreicht wird.

BEHANDLUNGSEINSTELLUNGEN FÜR KINDER:	BEHANDLUNGSEINSTELLUNGEN FÜR ERWACHSENE:
<p>Die Flussrate für KINDER liegt um 4-5 l/min.</p> <ul style="list-style-type: none"> - Knopf „FLOW“ im Uhrzeigersinn drehen, eine Flussrate von 4-5 l/min einstellen und ~1 Minute einatmen lassen. - Eingestellte Flussrate an der O₂-Säule (D - Bild A10) kontrollieren. - Der Beutel muss halb voll – halb leer sein. 	<p>Die Flussrate für ERWACHSENE liegt um 6-8 l/min.</p> <ul style="list-style-type: none"> - Knopf „FLOW“ im Uhrzeigersinn drehen, eine Flussrate von 6-8 l/min einstellen und ~1 Minute einatmen lassen. - Eingestellte Flussrate an der O₂-Säule (D - Bild A10) kontrollieren. - Der Beutel muss halb voll – halb leer sein.

Mit dem Knopf (Abbildung 18 Pos C) % N₂O das Lachgas verabreichen, **20%** einstellen, einige Minuten warten und die Reaktionen des Patienten beobachten.

Wenn der Patient nicht ausreichend sediert ist, Prozentwert allmählich erhöhen (z. B. 30%).

DER PROZENTANTEIL DES DEM PATIENTEN VERABREICHTEN STICKOXIDULS MUSS SO GERING WIE MÖGLICH SEIN, UM EINE GUTE NARKOSE ZU ERREICHEN (BASE LINE).

Ist die BASE LINE des Patienten bestimmt, FLUSSRATE und %N₂O im Krankenblatt eintragen, diese Daten werden bei den nächsten Sitzungen nützlich sein.



**DIE DEM PATIENTEN VERABREICHTE GASMISCHUNG:
DARF NICHT MEHR ALS 70% LACHGAS ENTHALTEN
DARF NICHT WENIGER ALS 30% SAUERSTOFF ENTHALTEN**



**Wenn der Patient Zeichen von Unwohlsein zeigt (Übelkeit, Schwindel, Kopfschmerzen), Behandlung sofort abbrechen.
Am Gerät gibt es die Taste „FLUSH“ (B - Bild 13).
Wird diese Taste gedrückt, füllt sich der Beutel mit Sauerstoff.
Durch Drücken des Beutels können dem Patienten größere Mengen reinen Sauerstoffs verabreicht werden.**

BEHANDLUNGSENDE

Die Behandlung wird beendet, wenn der Zahnarzt den Eingriff am Patienten abschließt.

Um die Behandlung abzuschließen:

- Ausgabe von LACHGAS unterbrechen, dazu den Knopf (C – Bild 18) %N₂O (gegen den Uhrzeigersinn) bis zum Anschlag drehen (0%).
- Wie zu Beginn der Behandlung 2 Minuten lang Sauerstoff mit einer Flussrate von 3 l/min verabreichen.
- Ausgabe von SAUERSTOFF unterbrechen, dazu den Knopf (A – Bild 18) FLOW (gegen den Uhrzeigersinn) bis zum Anschlag drehen.
- Schiebbarer Schlauchhalter lösen und Maske vom Patienten entfernen.

Bevor der Patient entlassen wird, sollte er (im Wartezimmer) etwa 5-10 Minuten lang unter Beobachtung bleiben.

Nach Ermessen des Arztes kann die Beobachtungszeit erhöht werden.

SCHLIESSEN DER GASFLASCHEN



Nach Gebrauch des Geräts sollten die Gasflaschen UNBEDINGT geschlossen werden.



Hahn der Lachgasflasche (N₂O) schließen (im Uhrzeigersinn drehen).



Hahn der Sauerstoffflasche (O₂) schließen (im Uhrzeigersinn drehen).

ABLAGE GASFLASCHEN



Die Flaschen am Ende des Tages in einem Depot gemäß den geltenden Gesetzen lagern.

7.3 REANIMATION MIT MASTER FLUX PLUS

* SATZ Art. 1504/A (Nicht mitgeliefert) (Abbildung A11)

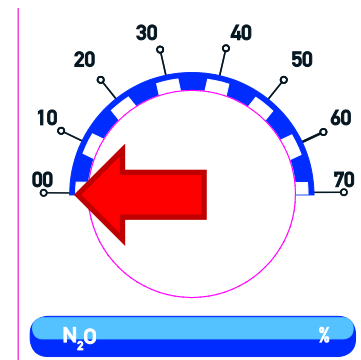
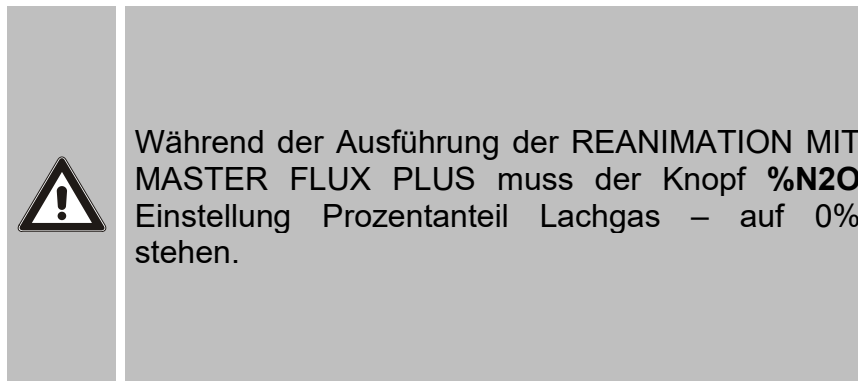

Ventil der Sauerstoffflasche LANGSAM aufdrehen (Hahn gegen den Uhrzeigersinn drehen), sicherstellen, dass die Lachgasflasche zuge dreht ist (Hahn im Uhrzeigersinn drehen).

Maskensatz von MASTER FLUX PLUS entfernen (vom Spiralschlauch abziehen).

Entsprechendes Anschlussstück **(30)** in den Spiralschlauch einstecken.

Entfernen Sie die Atembeutel **(F)**, und stellen Sie die entsprechende Kappe (T)

Ende des Schlauchs für Sauerstofftherapie **(31)** mit dem Anschlussstück **(30)** verbinden.

Anderes Ende des Schlauchs für Sauerstofftherapie über die entsprechende Kupplung mit dem unteren Dorn des Beatmungsbeckens **(32)** verbinden.

Maske **(33)** mit dem Ventil des Beatmungsbeckens verbinden.

Drehen Sie den Knopf **FLOW**, um das Sauerstoff auf die gewünschte Durchflussmenge fließen zu lassen, überprüfen Sie das Flussniveau.

Das Durchflussmessgerät des STICKOXIDULS = 0

Das Durchflussmessgerät des SAUERSTOFFS = EINGESTELLTER DURCHFLUSS

Maske am Patienten positionieren.

Bei der Betätigung des Beatmungsbeckens sind die Anweisungen für die Reanimation zu beachten.

Nach Gebrauch des Geräts sollte der Hahn der Sauerstoff-Gasflasche UNBEDINGT geschlossen werden (im Uhrzeigersinn drehen).



Bild 19

ABB.	POSITION	ANZAHL	ART.-NR.	BEZEICHNUNG
11	29	1	1504/A OPTION	SPIRALSCHLAUCH - CM88051
	30	1		FITTING – SMFA278
	31	1		SAUERSTOFFLEITUNG – CM84022
	32	1		BEATMUNGSBEUTEL – 1025-2
	33	1		BEATMUNGSMASKE – CM84014

8**WARTUNG****8.1****AUSTAUSCH DER GASFLASCHEN**

Wenn der Druck der Gasflaschen sehr niedrig ist (~10-20 bar), sind die Gasflaschen auszutauschen oder wieder aufzufüllen.

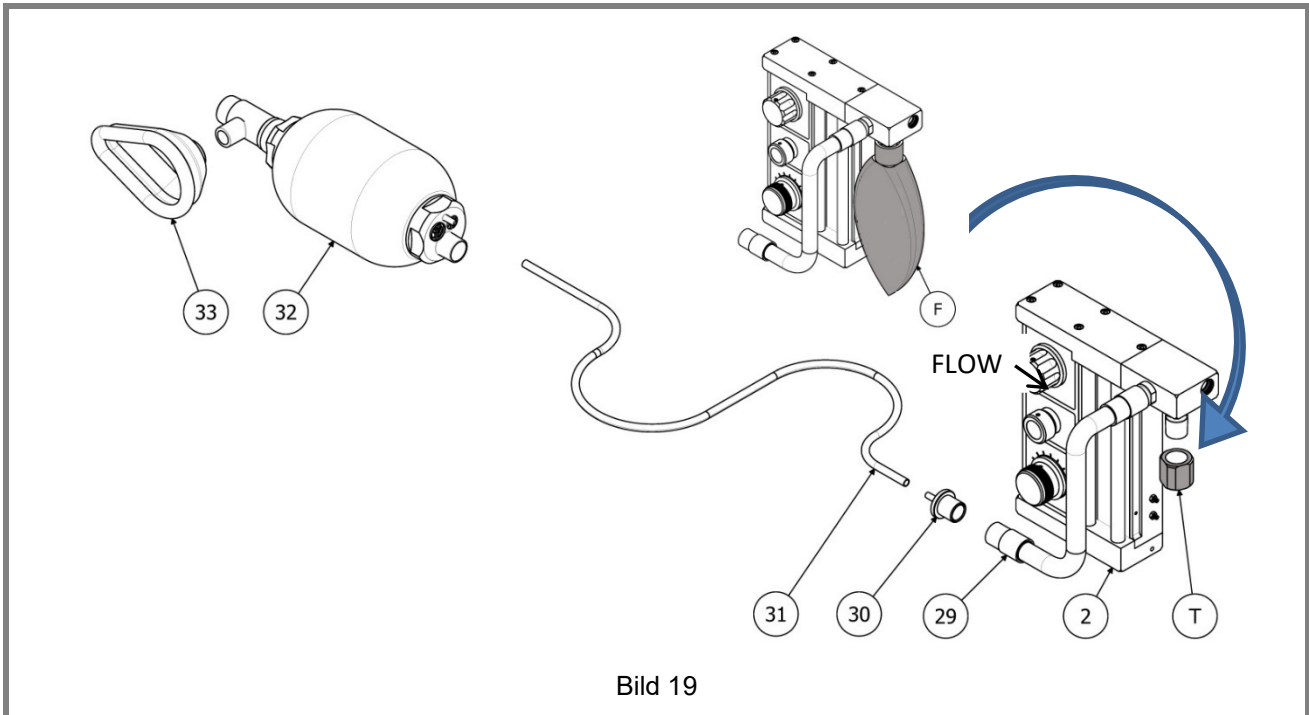

Wir empfehlen, die Lachgasflasche alle 2 Sauerstofftanks zu ersetzen.

Ventile langsam schließen (gegen den Uhrzeigersinn drehen).

Anlage entlasten, dazu die Knöpfe „FLOW“ und „%“ aufdrehen und am Ende wieder schließen.

Druckminderer demontieren und sauber und geschützt aufbewahren (siehe Installation).

Das Füllen, die Kontrolle und periodische Prüfung der Gasflaschen müssen durch Spezialfirmen gemäß den im Anwendungsland geltenden Vorschriften erfolgen.

8.2 Reinigung

Für Kunststoff keine aggressiven Reiniger benutzen.

Oberflächen des Geräts mit einem trockenen Tuch reinigen.

Vor und nach dem Gebrauch alle Teile, die mit dem Patienten oder seinem Atem in Berührung kommen, reinigen, abwischen oder sterilisieren.



Reinigen Sie den Plaxiglass®-Schutz des Durchflussgerätes mit einem antistatischen Reinigungsmittel.

Tabelle zur Reinigung der MASTER FLUX PLUS Bestandteile

FIG/POS	MATERIAL	ART.-NR.	BEZEICHNUNG	DAMPF-STERILISIERUNG	ANZAHL DER STERILISATIONSZYKLEN
3 / F	NEOPRENE	3MEDN0002	GUMMI-BEUTEL	NO	-



Informationen zur Reinigung der Maske (Silikon- und Shell-Ersatz) finden Sie im Benutzerhandbuch "Circuits and Masks".



DIE AUSSTATTUNG HÄNGT VOM MODELL AB

8.3 | Programmierte Wartung



Vor jedem Gebrauch die Integrität der Bauteile sicherstellen



Wird MASTER FLUX PLUS länger als einen Monat nicht benutzt, ist eine Funktionskontrolle durchzuführen.

Das MASTER FLUX PLUS-Gerät ist mit Sicherheitsvorrichtungen ausgestattet, die die korrekte Steuerung des Geräts regeln. Es ist jedoch ratsam, die Funktion des Geräts regelmäßig zu überprüfen, dazu die folgenden regelmäßigen Kontrollen durchführen.

8.2.1 Betriebskontrolle: Den Betrieb gemäß den Anweisungen im Abschnitt "7.1 Betriebsanleitung" überprüfen.

8.2.2.2 Überprüfung der Schwimmer in den Durchflussmessern: Sie müssen um sich selbst drehen und sich beim Einstellen der Durchflussmengen frei im Messkegel bewegen. Auch darauf achten, dass die eingestellten Werte stabil sind.

8.2.3 Kontrolle Taste FLUSH: Drücken und sicherstellen, dass der Schwimmer des N₂O-Durchflussmessers auf 0 (Null) sinkt, während der Sauerstoff die maximale Versorgung hat. Die Taste O₂ FLUSH loslassen und darauf achten, dass die O₂-Abgabe unterbrochen wird.

8.2.4 Überprüfung der N₂O-Blockierung: Eine Abgabe mit 50%iger Konzentration einstellen, die Sauerstoffflasche schließen (und so die Situation der leeren Flasche simulieren) und sicherstellen, dass nach einigen Sekunden eine komplette Blockierung der Abgabe von N₂O vorliegt.

8.2.5 Prüfung der Leckagen: Den Drehknopf "FLOW" schließen (A – Abbildung 9). Die Ventile der Sauerstoff- und Lachgasflaschen öffnen und die von den Manometern angezeigten Werte erfassen. Die Flaschenventile schließen. ~ 5 Minuten verstreichen lassen und die neuen, von den Manometern angezeigten Werte, erfassen. Wenn die Werte übereinstimmen, weist das Gerät keine Leckagen auf.



Ausschließlich Original-Ersatzteile und -Zubehör verwenden.



DRUCKMINDERER

DEN ANWEISUNGEN IN DEN BETRIEBSANLEITUNGEN DER GERÄTE FOLGEN.



MASKEN UND VOLLSTÄNDIGER KREISLAUF

DEN ANWEISUNGEN IN DER BETRIEBSANLEITUNG KREISE UND MASKEN DER GERÄTE FOLGEN.

SITUATIONEN, DIE WÄHREND DES BETRIEBS AUFTRETEN KÖNNEN:

Problem	Mögliche Ursachen	Abhilfe
Keine Sauerstoffausgabe	Gasflasche leer	Gasflasche auffüllen
	Druckminderer funktioniert nicht	Druckminderer austauschen
	Probleme im Durchflussmesser	Kontrolle des Geräts bei Tecno-Gaz
Keine Lachgasausgabe	Sauerstoffmangel	Gasflasche auffüllen
	Druckminderer funktioniert nicht	Druckminderer austauschen
Lachgasanzeiger springt in oberen Bereich	Falsche Bedienung	Knopf „FLOW“ auf null stellen Ordnungsgemäßen Betrieb wiederherstellen
	Inneres Problem	Das Gerät soll bei Tecno-Gaz überprüft werden

Bei Störung oder Überholung wenden Sie sich direkt an der telefonischen Service von:

TECNO –GAZ S.p.A.

Strada Cavalli 4, 43038, Sala Baganza, Parma, ITALIA.

www.tecnogaz.com

PHONE	+39 0521 83.80
FAX	+39 0521 83.33.91
@	cme2@tecnogaz.com

Die Service dann schätzt, wenn das Gerät zurückgeschickt werden soll.

Nachdem ein Techniker das Gerät überprüft hat, wird er einen Kostenvoranschlag vorbereiten, der dem Verkäufer für Annahme geschickt wird

Nachdem der Kostenvoranschlag schriftlich akzeptiert geworden ist, das Gerät repariert und zurückgeschickt, das laut die in Kostenvoranschlag aufgelistete Zeiten.

Das Gerät soll zurückgeschickt wie folgt:

- In der Original-Verpackung verpackt. Wenn Sie dieses nicht mehr zur Verfügung haben, dann benutzen Sie eine geeignete Verpackung. Die Haftbarkeit von der Lieferung bleibt auf Senderlasten.
- Die Steuereinheit und die Druckregler nur in einer sauberen Sauerstoffverpackung einpacken.
Die Druckminderer dürfen nicht verschmutzt werden (Reinigungsmittel, Alkohol, Öl,...); sollte der Service die Verpackung als nicht geeignet halten, dann werden die Druckminderer verschrottet.
- Mit einer schriftlichen Störbeschreibung begleitet.
- Immer frachtfrei versenden, andernfalls werden die getragenen Versandkosten in Rechnung gestellt.

Die bei uns eingetroffene Verpackungen, die nicht original sind, werden entsorgt.

Die Maschine wird in Original-Verpackung zurückgeschickt, die entsprechenden Kosten werden in Rechnung gestellt

ÍNDICE

- 1. EMPLEO Y DESTINO DE USO**
- 2. SEGURIDAD**
 - 2.1 MARCADO DE SEGURIDAD
 - 2.2 DISPOSITIVOS DE SEGURIDAD
 - 2.3 MANIPULACIÓN
 - 2.4 ELIMINACIÓN
- 3. DATOS TÉCNICOS**
- 4. DESEMBALAJE**
- 5. COMPONENTES**
 - 5.1 LISTA DE COMPONENTES SUMINISTRADOS
 - 5.2 COMPONENTES VERSIÓN MEUBLE
 - 5.3 COMPONENTES VERSIÓN DE PARED
 - 5.4 INTERFAZ DE USUARIO
 - 5.5 MÁSCARAS
 - 5.6 MÁSCARAS MEDIDA
 - 5.7 CIRCUITO DE MÁSCARAS
- 6. INSTALACIÓN**
 - 6.1 INSTALACIÓN MASTER FLUX PLUS CON MUEBLE
 - 6.2 INSTALACIÓN MASTER FLUX PLUS DE PARED
 - 6.3 CONEXIÓN DE LOS CIRCUITOS Y DE LOS ACCESORIOS
 - 6.4 EVACUACIÓN DE LOS GASES QUE SE EMANAN
 - 6.4.1 CONEXIÓN DIRECTA AL EXTERIOR DE LA CONSULTA
 - 6.4.2 CONEXIÓN AL ASPIRADOR QUIRURGICO
- 7. FUNCIONAMIENTO DEL DISPOSITIVO**
 - 7.1 COMANDOS Y DISPOSITIVOS DE LA INTERFAZ DE USUARIO
 - 7.2 INSTRUCCIONES DE USO
 - 7.3 REANIMACIÓN CON MASTER FLUX PLUS
- 8. MANTENIMIENTO**
 - 8.1 SUSTITUCIÓN DE LAS BOMBONAS
 - 8.2 LIMPIEZA
 - 8.3 MANTENIMIENTO PROGRAMADO
- 9. SEÑALES**
- 10. PROCEDIMIENTOS PARA EL SERVICIO Y LA ASISTENCIA**

USO PREVISTO

El MASTER FLUX PLUS es un dispositivo para suministrar una mezcla de O₂ y de N₂O al paciente, usando técnicas de sedación consciente /analgesia sedativa.

USO

En la mezcla suministrada los valores de concentración son:

O₂ ≥ 30 %

N₂O ≤ 70 %

La suministración se realiza con una mascarilla nasal, el paciente debe inspirar la mezcla respirando por la nariz.

La sedación consciente está recomendada para todos los pacientes de la consulta odontológica, tanto adultos como niños.

La sedación consciente permite que los pacientes se sometan a cuidados odontológicos sin el miedo y la ansiedad que los pacientes suelen experimentar al entrar en la consulta del dentista.



LA SEDACIÓN CONSCIENTE NO SE RECOMIENDA DURANTE:

- EL EMBARAZO
- EN PACIENTES TOXICÓMANOS
- EN PRESENCIA DE GRAVES INFECCIONES PULMONARES
- EN PERSONAS CON GRAVES ENFERMEDADES MENTALES



El MASTER FLUX PLUS debe usarlo solo personal médico que haya recibido una específica preparación.



No utilice este dispositivo para suministrar anestesia general o local o combinado con un sistema general de anestesia.



La ley limita la venta de este dispositivo solo a médicos y a odontólogos.

ATENCIÓN



No intente reparar, modificar o calibrar este dispositivo. Si se realiza una reparación no autorizada o se abusa de este dispositivo, se incide de forma negativa sobre sus prestaciones y sobre la validez de la garantía.



Antes de cada uso controle que la conexión de los gases de alimentación sea correcta.



El dispositivo suministra fármacos solo para la sedación consciente



Las contraindicaciones sobre el uso del fármaco se indican en la tarjeta de seguridad y en la documentación anexa al suministro del fármaco. Si no está presente, solicítela al proveedor del gas.



No quite la placa del producto que indica el número de registro y el lote de producción.



No sustituya los reductores del equipamiento con otros que no provengan del fabricante

2

SEGURIDAD

El PULSIOXÍMETRO debe usarse de forma rutinaria durante la sedación consciente.

Significado de la lectura de los valores detectados:



Niveles de saturación de O2	Grado de hipoxia
≥ 95 %	No hay hipoxia
90-94 %	Hipoxia leve
85-89 %	Hipoxia moderada
84 %	Hipoxia grave

2.1 Marcado de seguridad

El dispositivo cumple con la Directiva 93/42 CEE y sucesivas modificaciones e integraciones. La declaración de conformidad se anexa al dispositivo.

2.2 Dispositivos de seguridad

El dispositivo se suministra con sistema de seguridad:

- Si se reduce la presión del oxígeno (O₂), se interrumpe automáticamente el suministro de protóxido de nitrógeno (N₂O).
- Lleva un sistema de mezcla incorporado que regula el N₂O de forma que esté siempre presente una cantidad mínima de O₂ igual al menos al 30 % en la mezcla de gas.
- Si el flujo de la mezcla de gas se interrumpe, el paciente aspira aire desde el exterior mediante una válvula de seguridad específica.
- Si el flujo cambia de dirección, regresando hacia el dispositivo, con una válvula se protege al paciente para que no vuelva a respirar los gases exhalados o las acumulaciones de anhídrido carbónico (CO₂).
- El selector de configuración del flujo controla el flujo total y regula los flujos de oxígeno y de protóxido de nitrógeno automáticamente con el porcentaje que se ha programado.
- El pulsador O₂ FLUSH, cuando está previsto, puede usarse para distribuir O₂ rápidamente directamente a la salida de la unidad de dosificación; permite distribuir flujos elevados de oxígeno puro.

ADVERTENCIAS Y NOCIONES ÚTILES



DURANTE LA SUMERSIÓN DE GAS ES INDISPENSABLE ESTAR

- PRESENTES EN TODO MOMENTO
- MANTENER LOS FLUJOS DE LOS GASES Y DEL OXÍGENO Y DEL PROTÓXIDO DE NITRÓGENO BAJO CONTROL
- CONTROLANDO LOS VALORES DEL FLUJO INDICADOS POR LOS CAUDALÍMETROS Y POR LA BOLSA DE CONTROL.

2.3 Manipulación



Para mover el dispositivo Master Flux Plus utilice solamente las asas del equipo.



Figura 1

	No empuje el dispositivo sin usar las asas correspondientes.
	No se sienta o apoye pesos sobre el dispositivo.
	Antes de mover el dispositivo vuelva a colocar con atención la máscara y los tubos en los sistemas de fijación correspondientes, evitando tropezones o roturas.

2.4 Eliminación

La eliminación del embalaje, del dispositivo y de cada uno de los componentes debe respetar las normas vigentes en el país de uso, para el tratamiento y la eliminación de residuos potencialmente biocontaminantes.

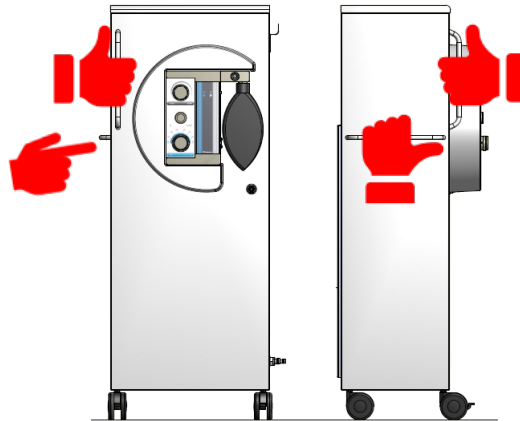
No vierta el material de embalaje en el ambiente.

El dispositivo no incluye partes eléctricas/electrónicas ni batería.

3

DATOS TÉCNICOS

ALIMENTACIÓN

Presión de alimentación	3.5 bar \cong 50 PSI (máx 6 bar \cong 87 PSI)
Caudal máximo	10 NI/min (litros por minuto)

PESO MASTER FLUX PLUS CON MUEBLE:

Peso sin bombonas	42 Kg
Peso máximo sostenible compartimiento bombonas plano ruedas	180 Kg
Peso máximo sostenible compartimiento bombonas superior	45 Kg

BOMBONAS PARA MASTER FLUX PLUS EN MUEBLE:

Altura máxima	950 mm
Diámetro máximo	140 mm

PESO MASTER FLUX PLUS EN PARED:

Peso de la caja fluxométrica	6,3 Kg
------------------------------	--------

CAUDALÍMETRO

Repetibilidad	+/-10 % caudal indicado
---------------	-------------------------

Lectura correcta: en línea con la parte superior plana.

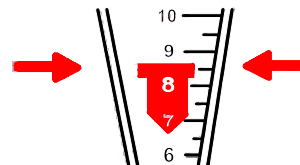

CONSUMOS:

A continuación se indica un ejemplo de consumo a tomar en cuenta como referencia teórica.

**BOMBONA DE OXÍGENO MÉDICO DE 10 L DE CAPACIDAD.
CARGADA CON PRESIÓN DE 200 Bar**

VOLUMEN DISPONIBLE	2000 Litros gaseosos
--------------------	----------------------

**BOMBONA DE PROTÓXIDO DE NITRÓGENO DE 10 L DE CAPACIDAD.
CARGADA CON 7 Kg DE GAS LÍQUIDO**

VOLUMEN DISPONIBLE	4600 Litros gaseosos
--------------------	----------------------

CONFIGURANDO:

DISTRIBUCIÓN	10 NL/min
MEZCLA	50 %

AUTONOMÍA:

OXÍGENO	400 min
PROTÓXIDO DE NITRÓGENO	950 min



En función de las medias de consumo del gas TECNO-GAZ aconseja sustituir la bombona de óxido nitroso cada 2 bombonas de oxígeno.



Figura A



Figura B

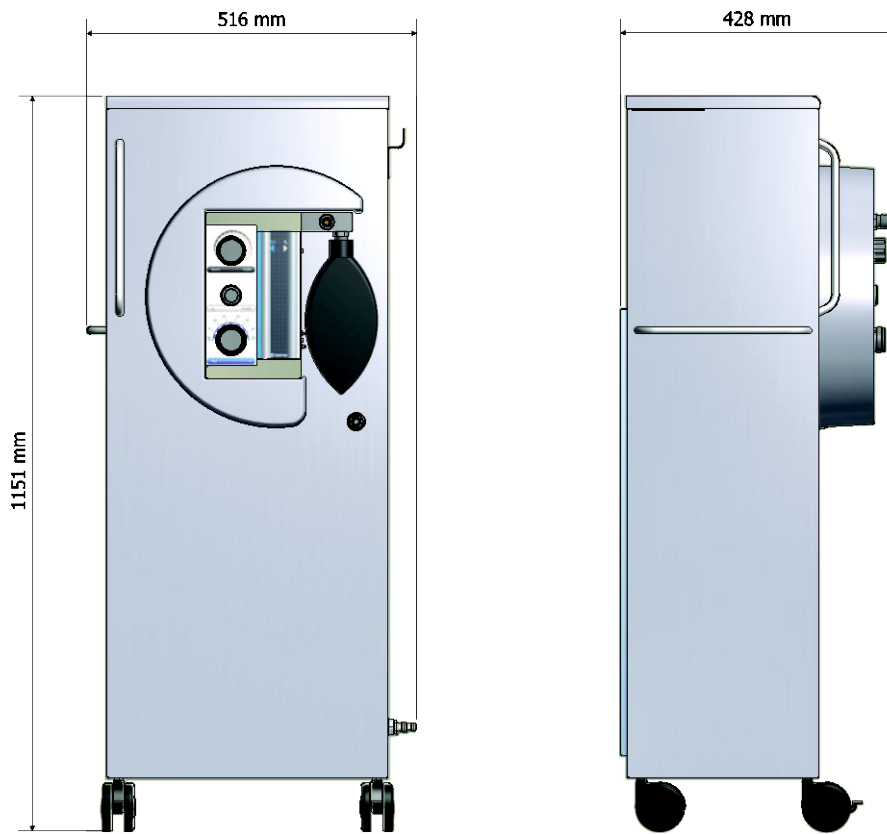

NO SE PERMITE SUPERPONER LOS MUEBLES MASTER FLUX PLUS EMBALADOS

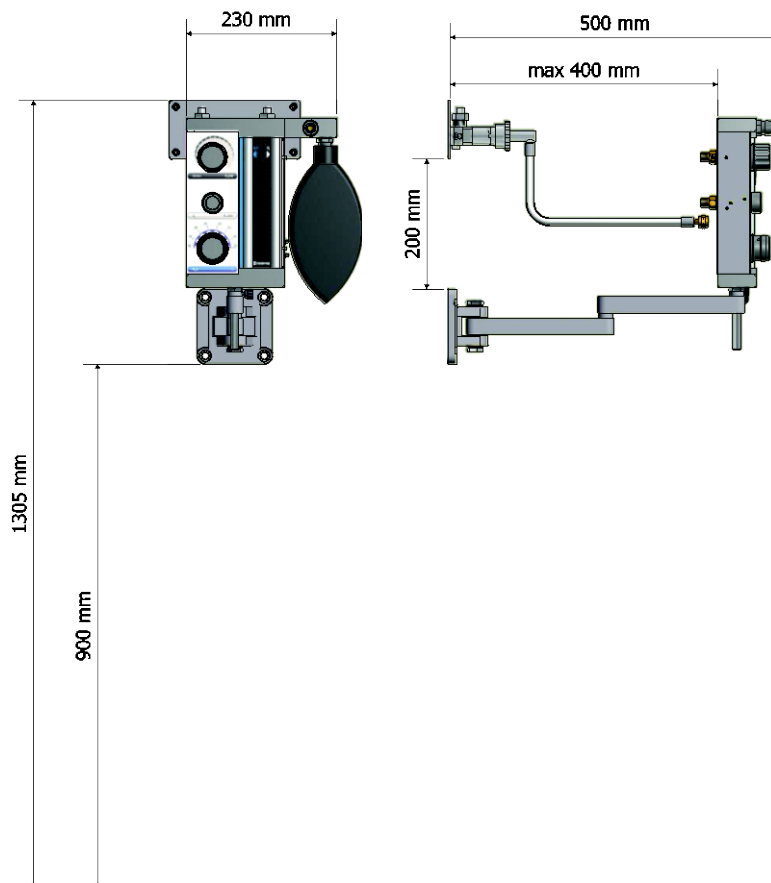

El embalaje no puede recibir golpes y tiene que ser manejado con cuidado, sin hacerlo rodar o caer.



No utilice aparatos que presenten daños evidentes debidos al transporte.



Quite el embalaje y controle las condiciones del aparato.



El embalaje debe conservarse durante todo el periodo de garantía.
El fabricante no acepta devoluciones sin el embalaje original.



Los dispositivos embalados deben conservarse en lugares secos y a temperatura entre los +5 / y los +40 °C.

05

COMPONENTES

5.1

Lista de componentes suministrados

ARTÍCULO	MF010ZMF Master Flux Plus de pared con Reductores con Oxido AFNOR y Óxido Nitroso UNI	SMFA301	SMFA301	SMFA301	1601AS Master Flux Plus de pared con cajas de engranajes con ensamblables UNI de oxígeno y óxido nitroso	MF009ZMF Master Flux Plus con meuble sin kit de caja de cambios	MF006ZMF Master Flux Plus con meuble con reductores con oxígeno AFNOR y óxido nitroso UNI	1600ASD Master Flux Plus con meuble con reductores con oxígeno y óxido nitroso DIN	1600ASF Master Flux Plus con meuble con reductores con oxígeno y óxido nitroso AFNOR	1600AS Master Flux Plus con meuble con reductores con oxígeno y óxido nitroso UNI
MEUBLE	SMFA301	SMFA301	SMFA301	SMFA301	SMFA301	2ZMFA0020	2ZMFA0020	2ZMFA0020	2ZMFA0020	2ZMFA0020
KIT MASTER	2ZZMFA0065	2ZZMFA0063	2ZZMFA0062	2ZZMFA0057	2ZZMFA0059	2ZZMFA0058	2ZZMFA0061	2ZZMFA0060	2ZZMFA0060	2ZZMFA0060
REDUCTOR N₂O	SMFA360	SMFA360	SMFA360	SMFA360	SMFA360	MF011ZMF	MF011ZMF	MF011ZMF	MK005ZMF	MF011ZMF
REDUCTOR O₂	SMFA361	SMFA358	MF003ZMF		1513A4F	1513A4D	1513A4F	1513A4	1513A4F	1513A4
MÁSCARAS	<p>MF820ZMF Master Flux circuit</p> <p>MF824ZMF Circuito de succión Master Flux Plus (nuevo)</p> <p>MF835ZMF Intelliflux 1 máscara completa Master Flux más 0-4 años</p> <p>MF836ZMF Intelliflux 2 máscara completa Master Flux más 4-10 años</p> <p>MF837ZMF Intelliflux 3 máscara completa Master Flux plus> 10 años</p>									

5.2

COMPONENTES versión meuble



Figura 2

FIGURA	POSICIÓN	CANT.	CÓDIGO	DESCRIPCIÓN
3	1	1	SMFA144	COBERTURA DE PLÁSTICO
	2	1	SMFA506	CAJA FLUXOMÉTRICA
	3	3	SMFA223	DISTANCIADOR
	4	3	CM25021	TORNILLO CON ALETAS M5
	5	3	3MECQ0010	SEPARADOR
	6	3	CM20015	ARANDELA
	7	3	CM25019	TUERCA CON ALETAS M6
	9	2	SMFA237	PORTA GOMA PARA ELIMINAR EL GAS

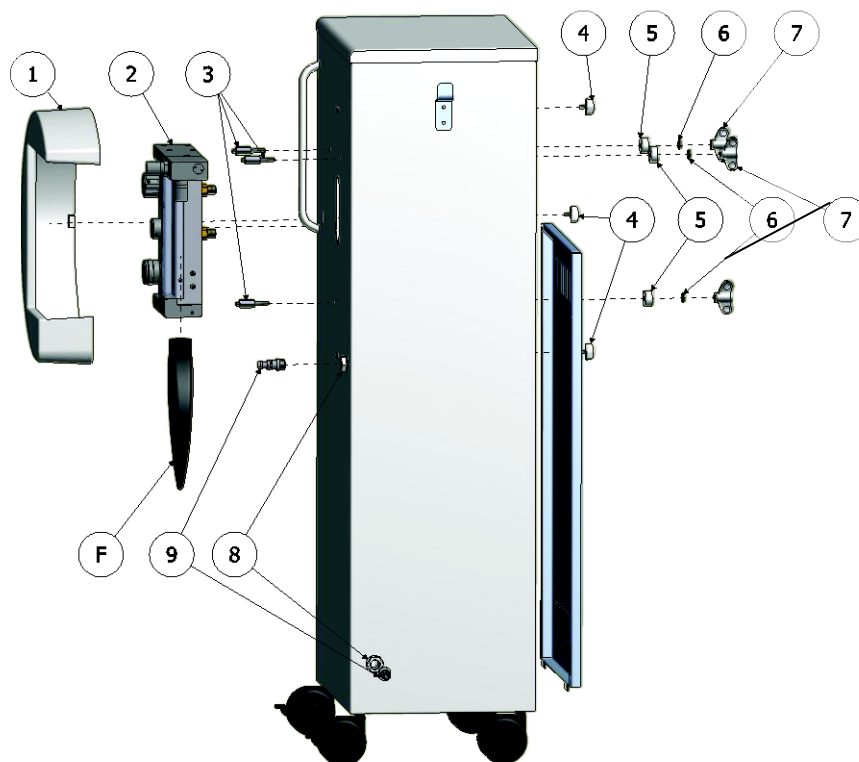

Figura 3-4

DE PARED (Figuras 3-4)

FIGURA	POSICIÓN	CANT.	CÓDIGO	DESCRIPCIÓN
4	10	1	SMFA313	PERNO
	11	1	SMFA364	TUBO DE O ₂
	12	1	SMFA365	TUBO DE N ₂ O
	13	1	SMFA301	SOPORTE DE PARED
	14	1	SMFA501	PLACA DE PARED
	15	1	CM30011	MANDO DE FIJACIÓN DEL PERNO

5.4

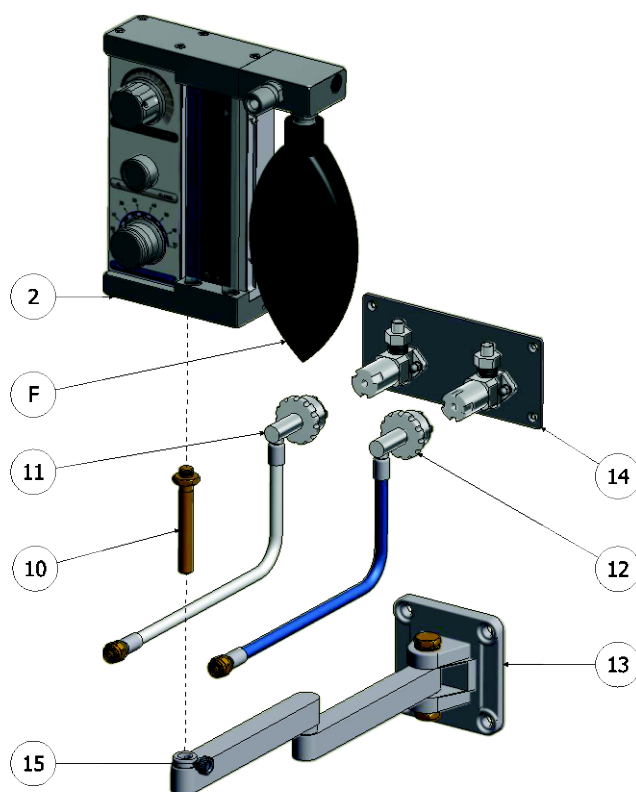
INTERFAZ DE USUARIO



Figura 5

A	Mando FLOW
B	Pulsador FLUSH
C	Mando % N ₂ O
D	Caudalímetro N ₂ O
E	Caudalímetro O ₂
F	Balón autoinflable
G	Portagoma para conectar la máscara

5.5

MÁSCARAS

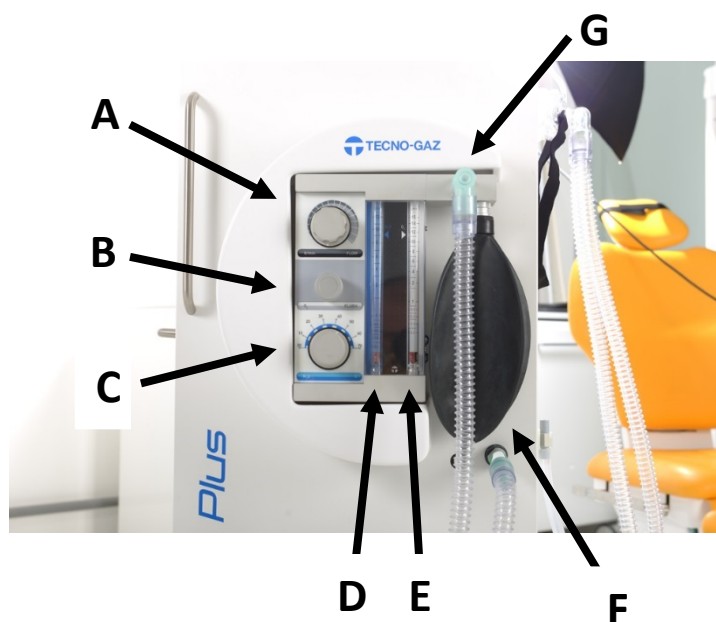

Figura 6

①	Área de apoyo para la frente del paciente
②	Entrada de gas con válvula antirretorno
③	Salida de gas con válvula de retención + flecha impresa en la PC para indicar la dirección del flujo
④	Banda elástica en velcro con ganchos de plástico

5.6

MÁSCARAS MEDIDAS

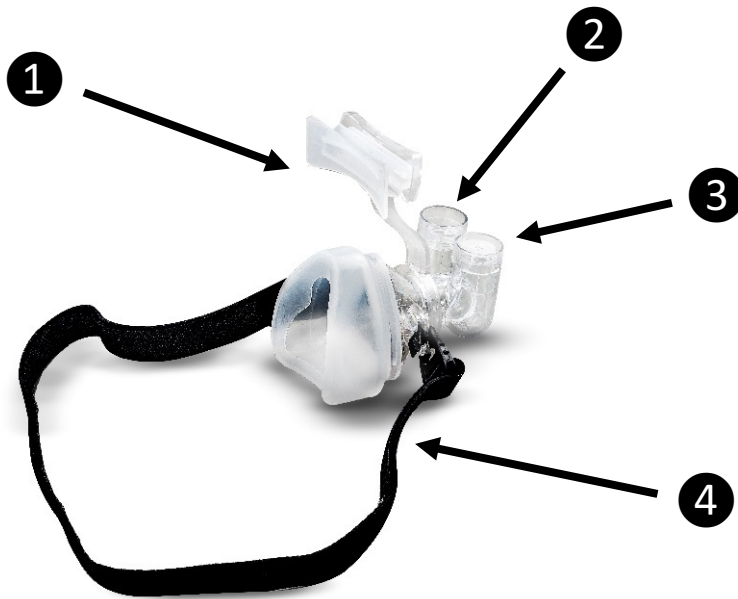
MF835ZMF	MF836ZMF	MF837ZMF	MF838ZMF
MÁSCARA 1	MÁSCARA 2	MÁSCARA 3	MÁSCARA 4
0-4 años	4-10 años	>10 años	

Figura 7

5.7

CIRCUITO DE MASCARA



Figura 8

CIRCUITO COMPLETO DE MÁSCARAS



Figura 9



Para partes de componentes individuales, vea el manual de usuario para "Circuitos y máscaras".

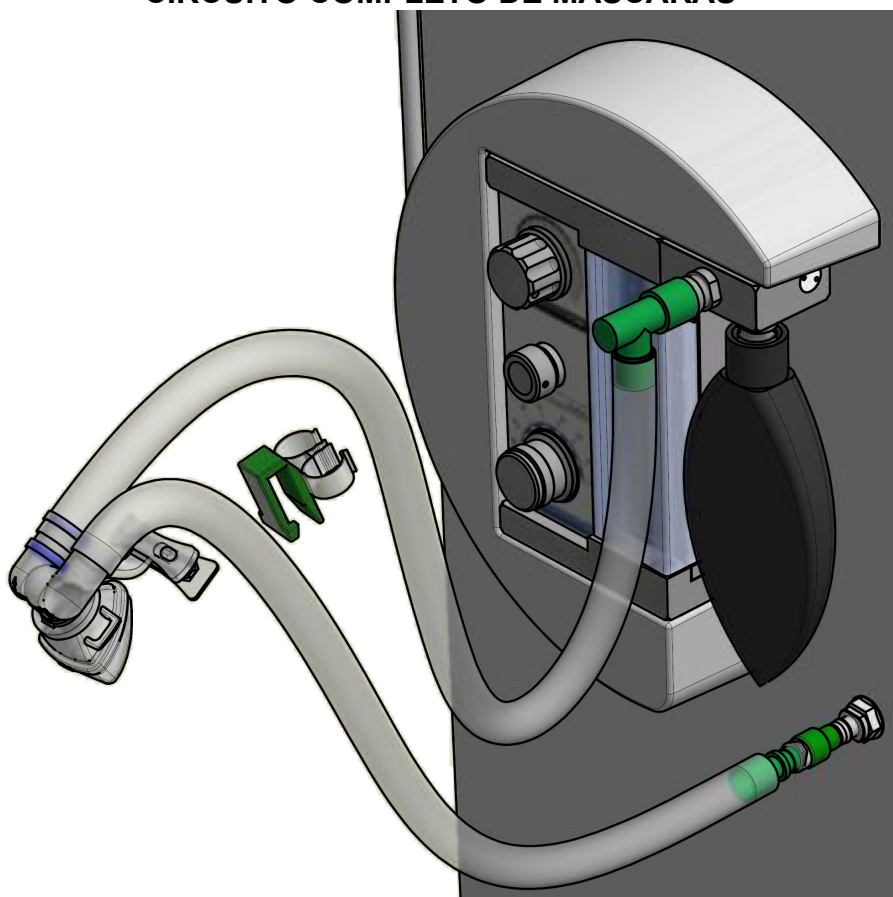

Quite el embalaje y controle las condiciones del aparato.
No utilice aparatos que presenten daños evidentes debidos al transporte.

6.1 *Instalación MASTER FLUX PLUS con mueble*

MONTAJE DE LA CAJA FLUXOMÉTRICA (Figura 2)

ver adjunto Guía rápida 0ZMFI0007

Enrosque los 3 separadores de acero (3) a la caja fluxométrica (2).

Quite las protecciones de los nipples de alimentación de la caja fluxométrica.

Monte la caja fluxométrica en el mueble introduciendo los separadores de acero (3) en los correspondientes agujeros del mueble, fijándolos al mismo con los 3 separadores de plástico (5), las 3 arandelas(6) y las tres tuercas con aletas (7) que se le suministran.

MONTAJE CUBIERTA FRONTAL (Figura 2 Pos 1)

ver adjunto Guía rápida 0ZMFI0007

Coloque la cubierta de plástico cerca de los tres agujeros del mueble.

Fije la cubierta de plástico enroscando los tres tornillos con aletas (4) que se le suministran.

MONTAJE DEL PORTA-GOMA DE DESCARGA (Figura 2 Pos 9)

ver adjunto Guía rápida 0ZMFI0007

Si se usa el tubo de descarga de los gases que emana, enrosque el porta goma que se le suministra en los racores de plástico.

MONTAJE DE LAS BOMBONAS (NO SUMINISTRADAS) (Figura 10)

Fije los reductores a las bombonas (vea el manual de instrucciones de los reductores).

Para bombonas de 5 l introduzca la repisa y fíjela con los topes adecuados.

Para las bombonas de 10 y de 14 l coloque la repisa al fondo del mueble.

Los manómetros de los reductores (M) deben estar colocados en lugar bien visible para el operador.

Bloquee las bombonas al mueble con la correa especial de Velcro que se suministra.

Enrosque la tuerca del tubo del reductor O₂ (R1) con el nipple de alimentación de la caja fluxométrica (I) (ROSCA DERECHA).

Enrosque la tuerca terminal del tubo del reductor N₂O (R2) con el nipple de alimentación de la caja fluxométrica (H) (ROSCA IZQUIERDA).

Cierre la puerta posterior usando los dos imanes colocados en la parte superior.



Figura 10

FIGURA	POSICIÓN	CANT.	CÓDIGO	DESCRIPCIÓN
6	R1	1	1513A4	REDUCTOR O ₂ (ITA)
	R2	1	MF011ZMF	REDUCTOR N ₂ O (ITA)
	L	1		VÁLVULA
	M	1		MANÓMETRO

6.2 Instalación MASTER FLUX PLUS de pared

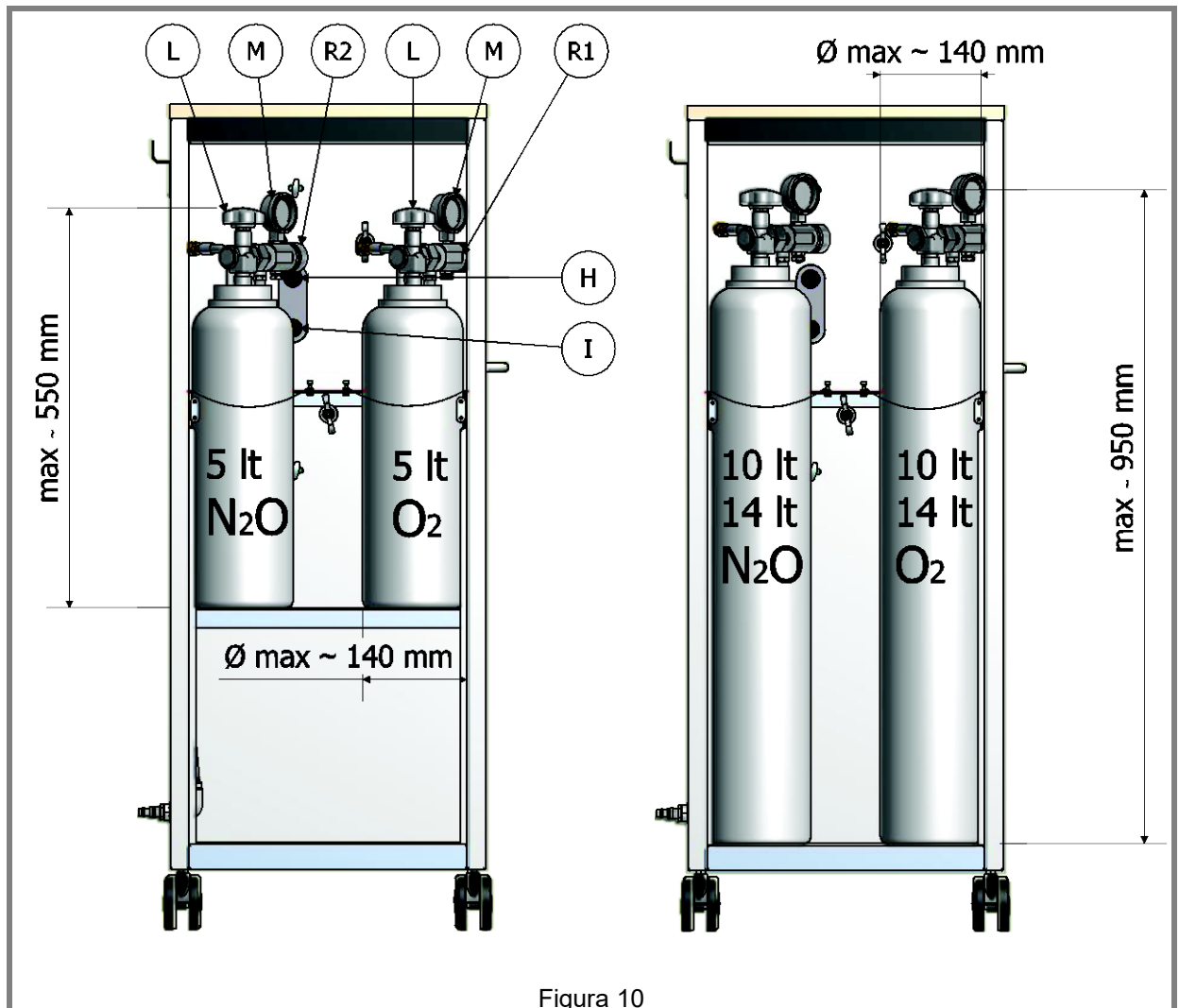

Figura 11



Figura 12

(Figura 5, 10)

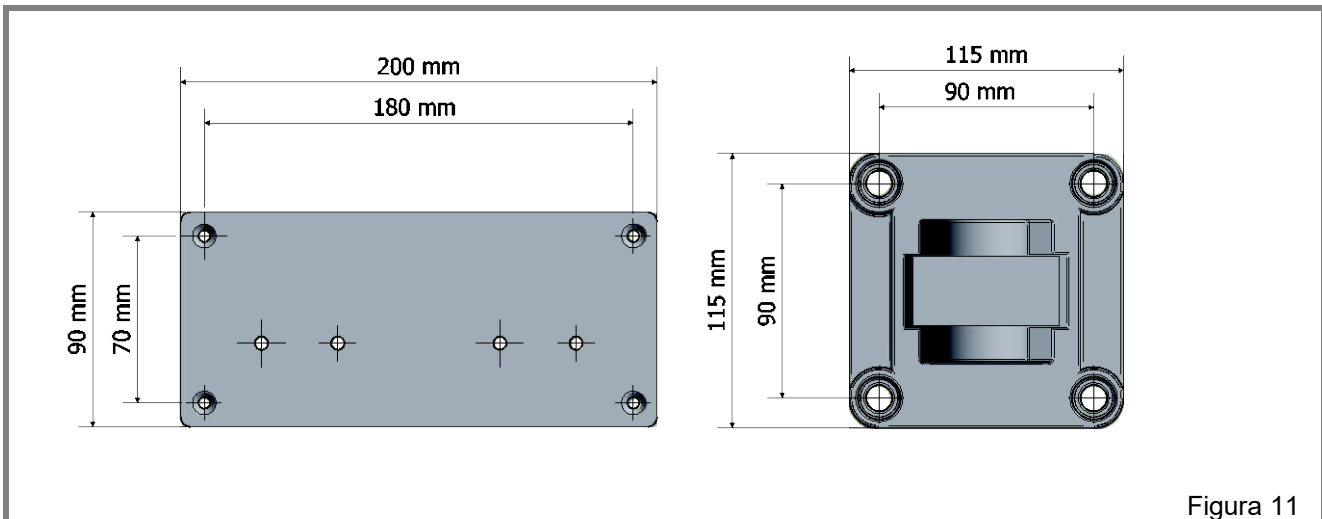
Fije el SOPORTE MASTER FLUX PLUS a la pared (13) utilizando 4 tacos de pared de $\varnothing 14$ mm M8.

Fije la PLACA MASTER FLUX PLUS de pared (14) con 4 tacos para pared de $\varnothing 8$ (mm).

Enrosque el perno en la base de la caja fluxométrica (10).

Introduzca el perno en la parte final del soporte (15).

Bloquee el perno al soporte con el correspondiente selector roscado.

Enrosque la tuerca del tubo O₂ con el niple de alimentación O₂ en la caja Fluxométrica (rosca DERECHA).

Conecte la tuerca del tubo N₂O con el niple de alimentación N₂O situado en la caja Fluxométrica (rosca IZQUIERDA).

Conecte los extremos libres de los tubos a las tomas de pared (presione los acoples y gire para bloquear el acople a la toma).

NOTAS SOBRE LA INSTALACIÓN CENTRALIZADA



La instalación deben efectuarla técnicos especializados, el sistema centralizado debe realizarse cumpliendo con las directivas vigentes.
Directiva Europea 93/42/CE

Conecte la toma de pared al punto equipotencial de la instalación eléctrica con los conectores de anilla que se le suministran.

Los reductores suministrados deben conectarse a las bombonas del sistema centralizado.

La salida del reductor **N₂O** incluye un tubo flexible en cuyo extremo está grapado un empalme macho con rosca **1/4" G** para conectarlo al sistema.

La salida del reductor **O₂** incluye un tubo flexible en cuyos extremos está grapado un empalme macho con rosca **1/8" G** para conectar al sistema.

La plancha de fijación no se suministra.

6.3 Conexión de los circuitos y de los accesorios:



Figura 13

FIGURA	POSICIÓN	CANT.	CÓDIGO	DESCRIPCIÓN
8	A	1		MANDO ' FLOW '
	B	1		PULSADOR ' FLUSH '
	C	1		MANDO ' % N2O '
	D	1		INDICADOR DE CAUDAL N2O
	E	1		INDICADOR DE CAUDAL O2
	F	1	3MEDN0002	BALÓN DE GOMA
	G	1		PORTA GOMA DE CONEXIÓN DE LA MASCARILLA
	H	1		NIPPLE N2O
	I	1		NIPPLE O2

Conecte el Balón de goma (F) a la caja fluxométrica, introduciéndolo a presión en el porta goma.

Conecte el tubo de entrada del gas, del circuito de la mascarilla, al porta goma (G).

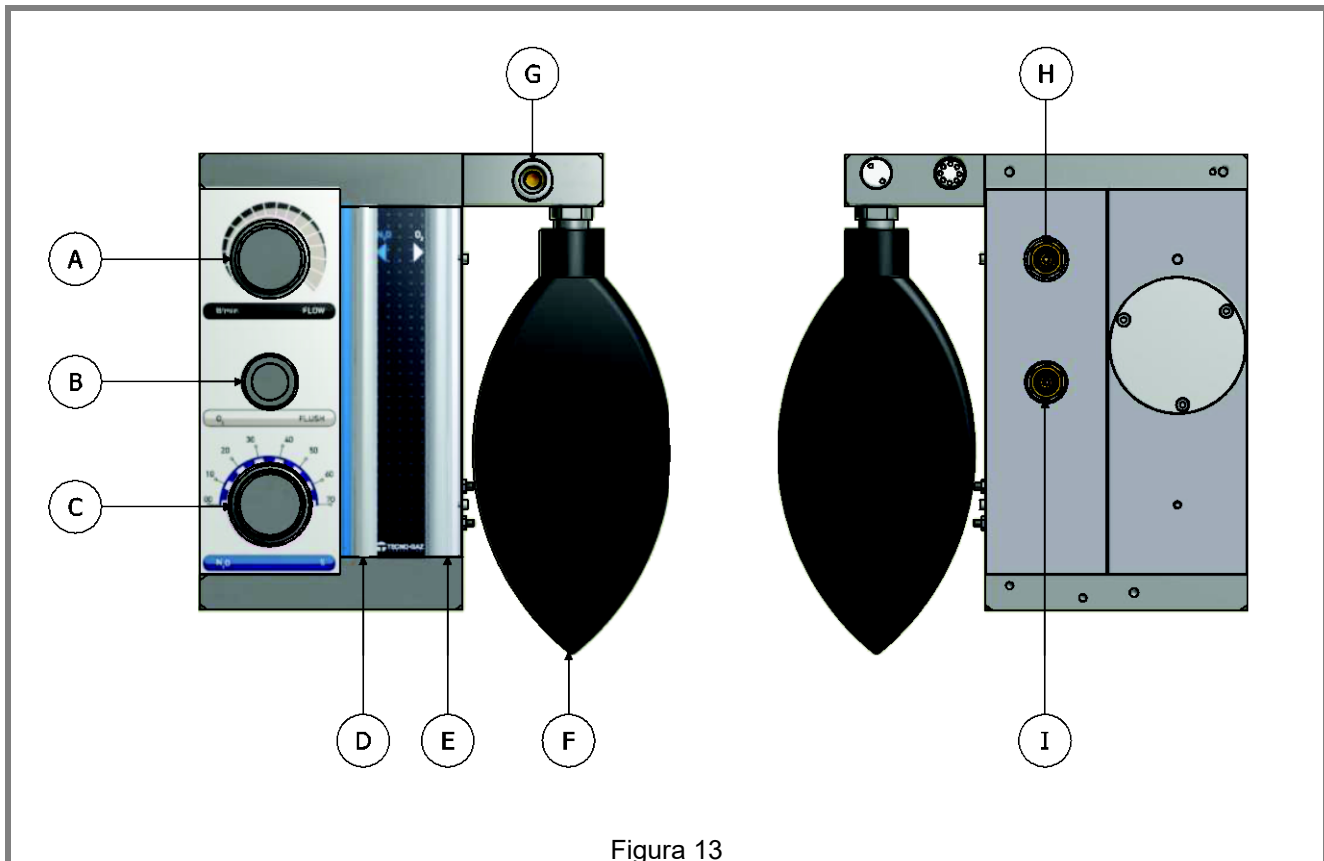
El tubo de descarga del gas se conectará de distinto modo, en base al tipo de evacuación de gas que se use. (vea 6.4 - EVACUACIÓN DE LOS GASES QUE SE EMANAN).

6.4 EVACUACIÓN DE LOS GASES QUE SE EMANAN

Para la seguridad del ambiente de trabajo y de los operadores, los gases emanados deben desviarse fuera del ambiente de trabajo.

Para descargar los gases al exterior pueden usarse dos sistemas:

- Conexión directa al exterior de la consulta
- Conexión al aspirador quirúrgico.

Es importante evaluar:

- La idoneidad del aspirador a la evacuación de los gases (N_2O y O_2)
- La descarga del aspirador debe ser al exterior y debe estar ventilada.

Controle la conformidad respecto a las normativas vigentes en el país de uso.

6.4.1 CONEXIÓN DIRECTA AL EXTERIOR DE LA CONSULTA

MASTER FLUX PLUS CON MUEBLE

Enrosque la boquilla (Figura 2 Pos 8/9) al mueble.

Elimine la válvula que se le suministra.

Conecte el tubo de descarga de gas del circuito de la mascarilla, a la boquilla (Figura 15).

Conecte el tubo espiralado, evacuación de gas (Figura 14), a la boquilla del mueble.

Coloque en el exterior del extremo del tubo espiralado y controle que lleve el filtro final.

MASTER FLUX PLUS DE PARED

Conecte el tubo, la descarga de gas del circuito de la mascarilla a la boquilla (Figura 14 Pos 36).

Coloque en el exterior del extremo del tubo espiralado y controle que lleve el filtro final (Figura 14 Pos 34).



FIGURA	POSICIÓN	CANT.	CÓDIGO	DESCRIPCIÓN
9	34	1	SMFA197	FILTRO - SMFA260
	35	1		TUBO – SMFA199
	36	1		EMPALME – SMFA257



Figura 15

6.4.2 CONEXIÓN AL ASPIRADOR QUIRÚRGICO

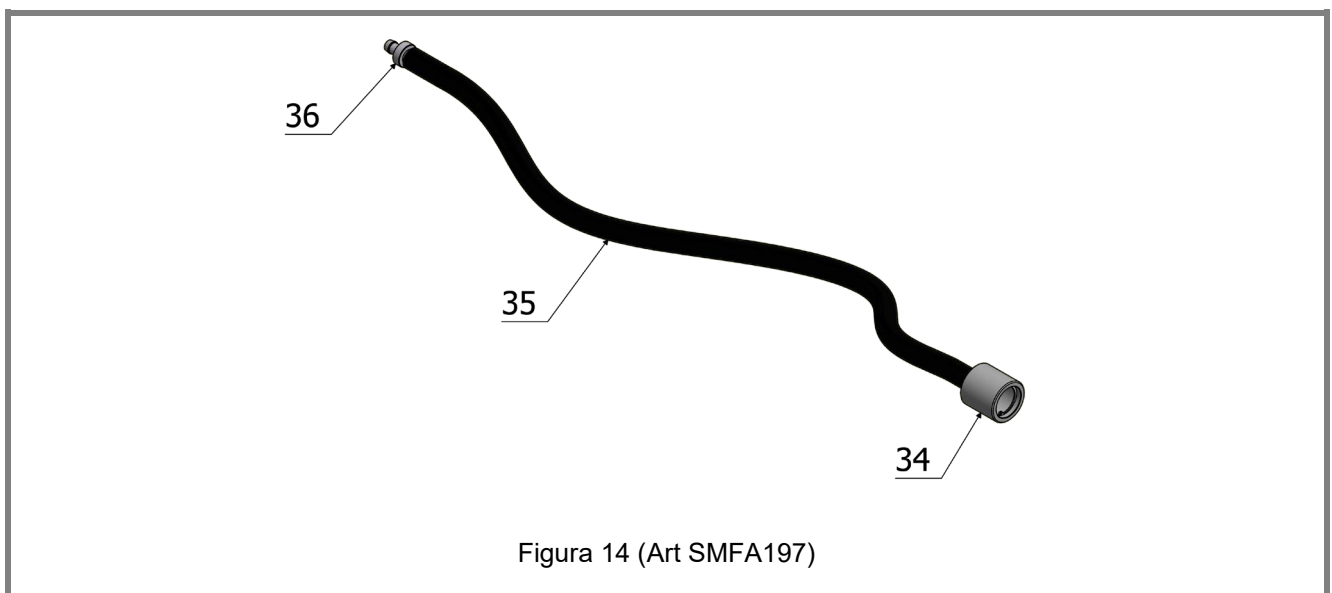
MASTER FLUX PLUS CON MUEBLE

Atornille las mangueras (Figura 2 Pos 8/9) al mueble.

Conecte el tubo, de descarga de gas del circuito de la mascarilla, a la válvula (Figura 17) que se le suministra.

Conecte el circuito de succión (Figura 16) a la conexión de la manguera.

Conecte la válvula al tubo del aspirador quirúrgico (Ø11)

MASTER FLUX PLUS DE PARED

Retire el tubo (Figura 16 Pos 43)

Conecte el tubo, descarga de gas del circuito de la máscara, a la válvula (Figura 16 Pos 44).

Conecte la válvula al tubo de succión quirúrgico (Ø11).

REGULACIÓN DE LA VÁLVULA

Gire la abrazadera perforada de la válvula (Figura 5 Pos 17) hasta que se cierren los agujeros.

Ponga en funcionamiento la distribución de los gases configurando ~10 l/min.

Ponga en marcha el aspirador quirúrgico configurando el valor de aspiración mínimo.

Observe el balón (Figura 8 Pos F).

Gire la abrazadera perforada de la válvula abriendo los agujeros progresivamente hasta conseguir que el balón esté en el estado más adecuado “MEDIO LLENO MEDIO VACÍO”.

ATENCIÓN

Variando los flujos que se distribuyen, puede que se necesite regular los flujos de aspiración correctos de los gases que se emanan.



Figura 16 (Art MF824ZMF)

FIGURA	POSICIÓN	CANT.	DESCRIPCIÓN
9A	41	1	REDUCCIÓN
	42	1	PARTE TERMINAL
	43	2	TUBOS
	44	1	VÁLVULA

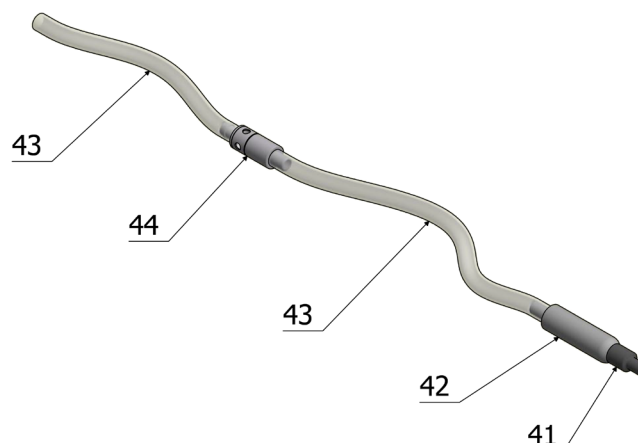

Figura 17

7 FUNCIONAMIENTO DEL DISPOSITIVO

7.1 COMANDOS Y DISPOSITIVOS DE LA INTERFAZ DE USUARIO



Figura 18

TECLAS MANDO (FIGURA A10)

A	POMO FLOW (CAUDAL) - REGULACIÓN FLUJO DISPENSADO
B	PULSADOR DE EMERGENCIA FLUSH (ENJUAGUE) - DISPENSACIÓN SOLO OXÍGENO
C	POMO REGULACIÓN % ÓXIDO NITROSO

ELEMENTOS DE CONTROL

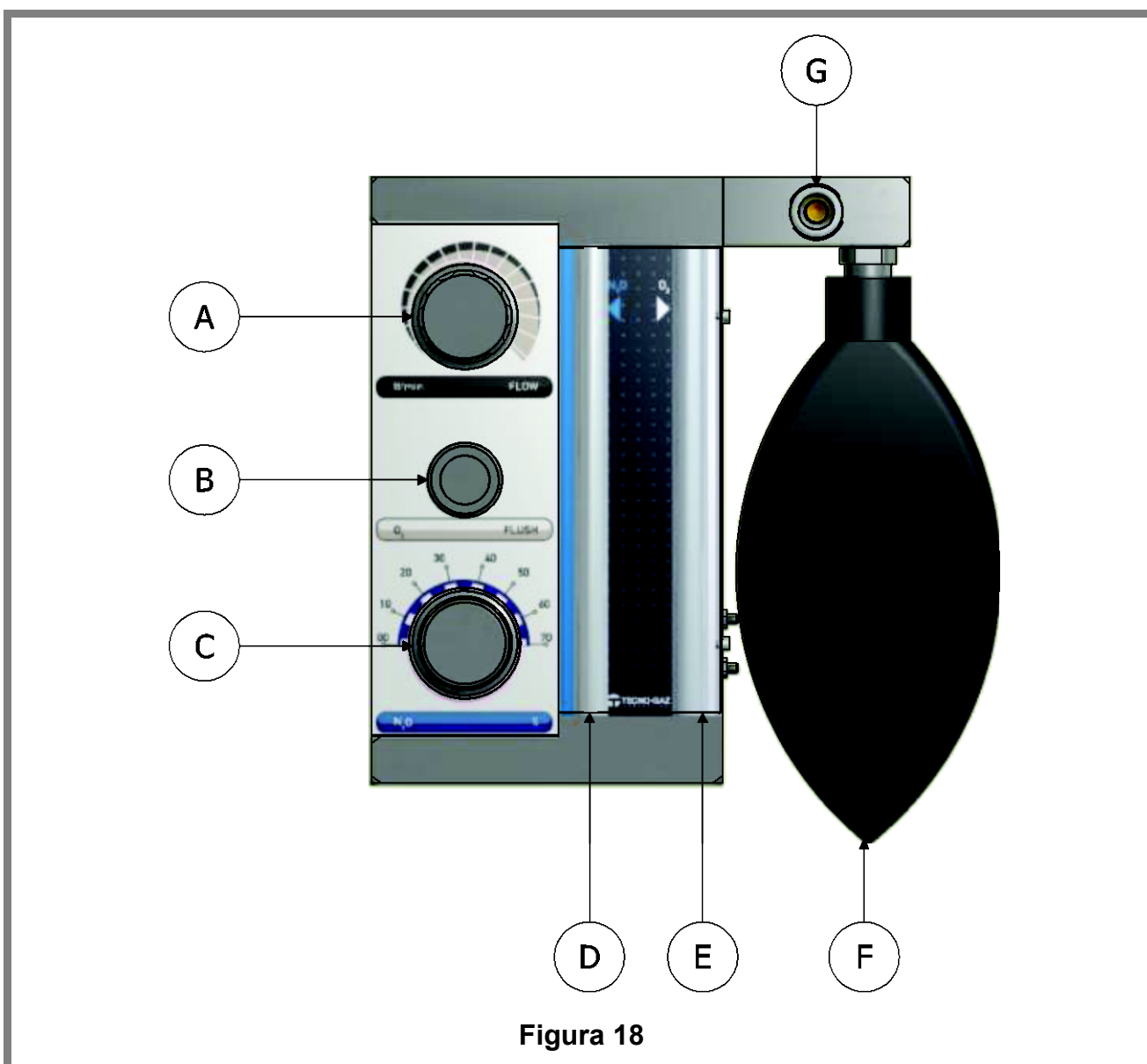





E	CAUDAL DE OXÍGENO PURO
D	CAUDAL DE ÓXIDO NITROSO PURO
F	BALÓN (CONTROL - CAUDAL IDÓNEO PARA EL PACIENTE)

7.2



INSTRUCCIONES DE USO

Antes de empezar a usar el dispositivo MASTER FLUX PLUS, en la versión de mueble, bloquee las ruedas, que llevan freno, empujando las lengüetas hacia abajo.

Si fuera necesario desplazar el aparato (por ejemplo de una habitación a otra) desbloquee las ruedas y empuje con suavidad el dispositivo utilizando las asas. Consulte el apartado 2.3

-  Evite golpes y movimientos repentinos que podrían causar caídas accidentales.
-  Desplace el MASTER FLUX PLUS y colóquelo sobre superficies sin inclinación y lisas.
-  Controle la estabilidad de las bombonas y que estén bien sujetas.
-  Cierre las bombonas antes de desplazar el dispositivo.
-  No use las manillas para elevar el dispositivo.
-  No mueva el dispositivo usando los mangos.
-  No exponga los controles a golpes involuntarios.

Cuando se usa el MASTER FLUX PLUS en la versión de pared, es posible desplazar y orientar la caja fluxométrica según se desea, agarrando la manilla correspondiente (Figura 4 Pos. 10).

-  **NO SE APOYE NI APOYE NINGÚN OBJETO EN LA CAJA FLUXOMÉTRICA (TANTO EN LA VERSIÓN CON MUEBLE COMO EN LA DE PARED). NO FUERCE EL BRAZO EN LA VERSIÓN DE PARED.**
-  **ABRA LAS VÁLVULAS DE LAS BOMBONAS O₂ Y N₂O LENTAMENTE, GIRE EN SENTIDO ANTIHORARIO LOS GRIFOS (Figura 6 Pos L).**

Lea la presión en los manómetros de los reductores de presión (vea DATOS TÉCNICOS) para calcular la autonomía de la bombona de oxígeno.

Controle que el balón y los tubos estén bien conectados en sus racores.

Escoja la mascarilla adecuada al paciente.



Coloque la mascarilla pegándola a la nariz del paciente.

Fije la mascarilla con el porta tubo de lazo corredizo, detrás del reposa cabezas del sillón.

Controle que los tubos del circuito de la mascarilla no tengan pliegues.

El operador debe colocarse de forma que pueda controlarlo visualmente:

- **Balón de goma** (Figura 18 Pos. F)
- **Caudalímetros** (Figura 18 Pos. D, E)

-  **Durante la terapia controle constantemente los fluidos que se visualizan en los caudalímetros (Figura 10 Pos D, E).**
-  **Antes de alejarse del paciente, incluso durante poco tiempo, interrumpa la sedación.**

Controle que el índice del mando (Figura 18 Pos C) %N₂O indique 0.

Suministre un flujo de 3 l/min de oxígeno, durante 30 segundos, con la ayuda del mando FLOW (Figura 18 Pos A).

COMUNIQUE AL PACIENTE QUE DEBE INSPIRAR Y ESPIRAR POR LA NARIZ.

Utilice el mando **FLOW (Pos A)**, para regular el flujo.

Varíe progresivamente el flujo, calcule cómo está el balón (**Pos F**), el balón debe tener una forma que definiremos como **medio lleno o medio vacío**.

Haga respirar al paciente al menos un minuto, antes de **evaluar el flujo**.

Cuando haya calculado el flujo más adecuado, teniendo en cuenta la capacidad pulmonar del paciente, regule la válvula de eliminación de gas como se indica en el apartado 6.4 'Evacuación de gases emanados'.

Con el mando de % (Figura 18 Pos C) se puede variar el porcentaje de protóxido de nitrógeno.

Los caudalímetros visualizan los litros/min de Protóxido de nitrógeno y de Oxígeno distribuidos.

La suma de las dos capacidades es la que se configura en principio en base a la capacidad respiratoria del paciente.



Las siguientes indicaciones son ejemplos de administración.

Cada usuario debe configurar el caudal y el porcentaje según el paciente sometido a la administración del fármaco.

ESPECIFICACIONES DE TERAPIA PARA NIÑOS:	ESPECIFICACIONES DE TERAPIA PARA ADULTOS:
<p>EL flujo para los NIÑOS se encuentra alrededor de los 4-5 L/min.</p> <ul style="list-style-type: none"> - Girar en sentido horario el mando "FLOW" configurando un flujo de 4/5 l/min y dejar inspirar durante ~1 minuto. - Controle el flujo configurado en la columna O₂ (Figura 10, Pos E). - El balón debe encontrarse medio lleno medio vacío. 	<p>El flujo para los ADULTOS se encuentra alrededor de los 6-8 L/min.</p> <ul style="list-style-type: none"> - Gire el mando "FLOW" en sentido horario, configurando un flujo de 6-8 l/min y deje inspirar durante ~1 minuto. - Controle el flujo configurado en la columna O₂ (Figura 10, Pos E). - El balón debe estar medio lleno medio vacío.

Con el mando (Figura 18 Pos C) % N₂O suministre el protóxido de nitrógeno, configure al **20%**, espere algunos minutos y observe cómo reacciona el paciente.

Si el paciente no está sedado, aumente progresivamente el porcentaje (ej. 30 %).

EL PORCENTAJE DE PROTÓXIDO DE NITRÓGENO SUMINISTRADO AL PACIENTE DEBE SER: LO MÁS BAJO POSIBLE PARA OBTENER UNA BUENA SEDACIÓN (BASE LINE).

Cuando se ha fijado el BASE LINE del paciente, marque el valor del FLUJO y el % de N₂O en el expediente médico, estos datos servirán para las siguientes sesiones.



LA MEZCLA DE GAS QUE SE SUMINISTRA AL PACIENTE:
NO DEBE SUPERAR EL 70 % DE PROTÓXIDO DE NITRÓGENO
NO DEBE TENER MENOS DEL 30 % DE OXÍGENO



Si el paciente muestra síntomas de malestar (náusea, vértigo, dolor de cabeza), interrumpa inmediatamente la terapia.
El dispositivo lleva un pulsador “FLUSH” (Figura 10 Pos B).
Presionando este botón el balón se llena de oxígeno.
Presionando el balón le suministramos al paciente elevadas cantidades de oxígeno puro.

FIN DE LA TERAPIA

La terapia termina cuando el odontólogo termina la intervención al paciente.

Para finalizar la terapia:

- Interrumpa la distribución de PROTÓXIDO DE NITRÓGENO girando el mando (Figura 10 Pos C) % N₂O (en sentido antihorario) hasta el final de carrera (0 %).
- Suministre (como al empezar la terapia) un flujo de 3 l/m de oxígeno durante 2 minutos
- Interrumpa la distribución de OXÍGENO girando el mando (Figura 10 Pos A) FLOW (en sentido antihorario) hasta final de carrera.
- Aflojando el bloqueador de tubo con lazo corredizo y quitando la mascarilla al paciente.

Antes de dar el alta al paciente, téngalo en observación (sala de espera) durante ~5÷10 minutos.

El médico puede que considere necesario aumentar el tiempo de observación.

CIERRE DE LAS BOMBONAS



Cuando termine de usar el dispositivo es **IMPORTANTE** que cierre las bombonas.



Cierre el grifo de la bombona del Protóxido (N₂O), (girando en sentido horario).



Cierre el grifo de la bombona del Oxígeno (O₂), (girando en sentido horario).

DEPÓSITO DE BOMBONAS



Al final del día, almacene los cilindros en un depósito de acuerdo con las leyes vigentes.

7.3 REANIMACIÓN CON MASTER FLUX PLUS

*(KIT Art. 1504/A No suministrado - Fig 11)



Las operaciones de REANIMACIÓN CON MASTER FLUX PLUS, deben efectuarse con el mando % N₂O de regulación del porcentaje de protóxido de nitrógeno, en la posición 0 %.

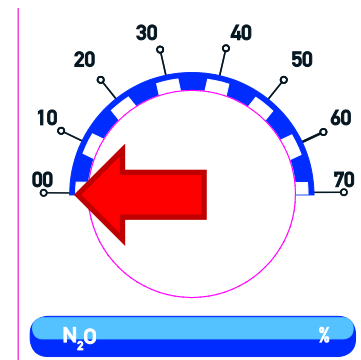

Abra la válvula de la bombona del oxígeno LENTAMENTE (gire el grifo en sentido antihorario), controle que la bombona del protóxido de nitrógeno esté cerrada (gire el grifo en sentido horario).

Quite el kit de mascarilla del MASTER FLUX PLUS extrayéndolo del tubo espiralado.

Introduzca el empalme correspondiente en el tubo espiralado **(30)**.

Quite la bolsa **(F)** e introduzca el tapón adecuado **(T)**.

Conecte el extremo de tubo de la terapia de oxígeno **(31)** al empalme **(30)**.

Conecte el otro extremo del tubo para terapia de oxígeno, al bollón inferior del balón de reanimación **(32)**, con el empalme correspondiente.

Conecte la mascarilla **(33)**, a la válvula del balón de reanimación.

Gire el mando **FLOW** para distribuir el Oxígeno con el flujo que desea, **CONTROLE LOS FLUJOS QUE SE VISUALIZAN.**

El caudalímetro del PROTÓXIDO DE NITRÓGENO = 0

El caudalímetro del OXÍGENO = FLUJO CONFIGURADO

Coloque la mascarilla al paciente.

Regule la bolsa del balón de reanimación conforme a las instrucciones para ello.

Cuando termine de usar el dispositivo es **IMPORTANTE** cerrar el grifo de la bombona del Oxígeno (girando en sentido horario).



Figura 19

FIGURA	POSICIÓN	CANT.	CÓDIGO	DESCRIPCIÓN
11	29	1	1504/A OPCIONAL	TUBO DE ESPIRALADO - CM88051
	30	1		EMPALME – SMFA278
	31	1		TUBO DEL OXÍGENO – CM84022
	32	1		BALÓN PARA REANIMACIÓN – 1025-2
	33	1		MASCARILLA DE REANIMACIÓN – CM84014

8

MANTENIMIENTO

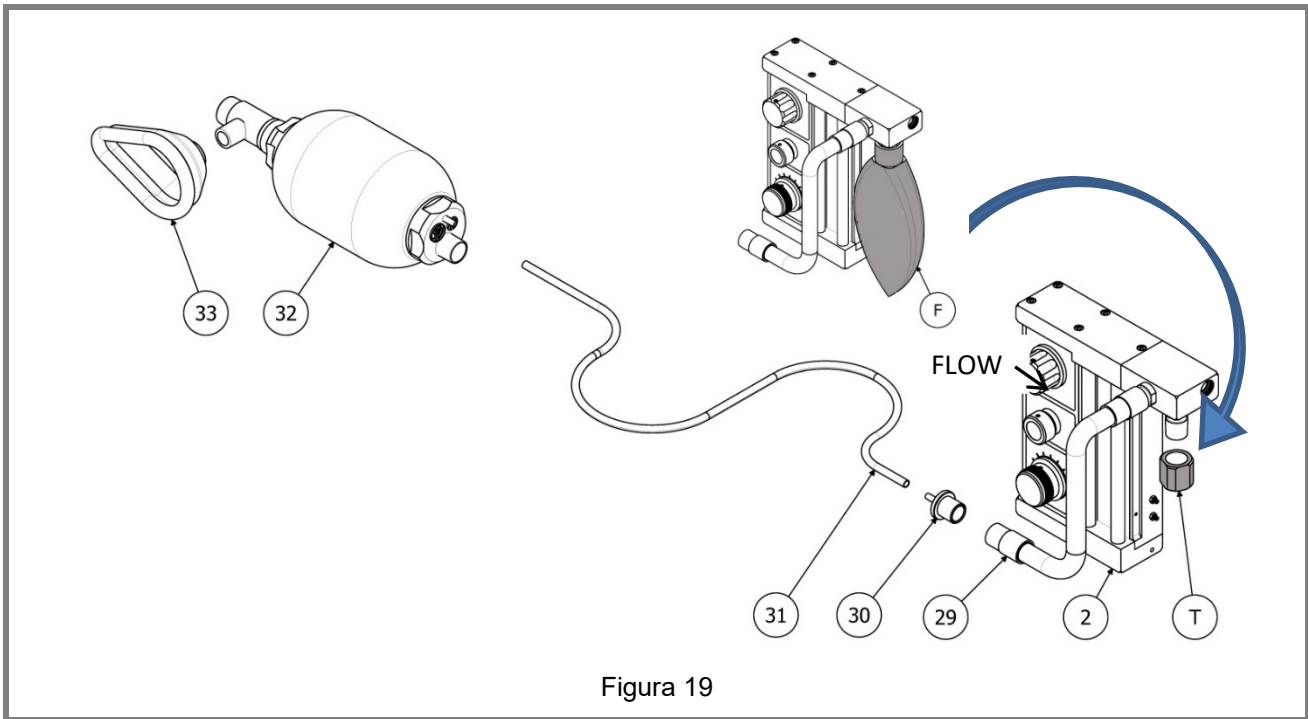
8.1

SUSTITUCIÓN DE LAS BOMBONAS

Si la presión de las bombonas es muy baja ~10÷20 bar, sustitúyalas o recargue.



Recomendamos reemplazar la botella de óxido nitroso cada 2 tanques de oxígeno.

Cierre las válvulas lentamente (gire en sentido antihorario).

Descargue la instalación con el mando "FLOW" y el '%', vuelva a cerrar el sistema.

Desmonte los reductores de presión, conservándolos en lugar protegido y limpio. (Vea instalación)

Debe efectuar la recarga, el control y el ensayo periódico de las bombonas a través de empresas especializadas conforme a las directivas vigentes en el país de uso.

8.2

LIMPIEZA



Utilice detergentes no agresivos para materiales plásticos.

Limpie las superficies del dispositivo con un trapo limpio.

Antes y después de usarlo, limpie con detergente o esterilice las piezas en contacto con el paciente o con su respiración.



Limpie con Detergente, con efecto antiestático, el Plexiglass® de protección de los caudalímetros

Tabla de limpieza de los componentes del MASTER FLUX PLUS

FIG/POS	MATERIAL	CÓDIGO	DESCRIPCIÓN	ESTERILIZACIÓN CON VAPOR	NÚMERO DE CICLOS DE ESTERILIZACIÓN
3 / F	NEOPRENE	3MEDN0002	BALÓN DE GOMA	NO	-



Para limpiar la máscara (partes de silicona y carcasa) consulte el manual de usuario "Circuitos y máscaras".



LOS ARTÍCULOS SUMINISTRADOS VARÍAN SEGÚN LA CONFIGURACIÓN DEL DISPOSITIVO



Verifique la integridad de los componentes antes de cada uso



En el caso de que el MASTER FLUX PLUS permanezca parado durante más de 1 mes, haga un control funcional.

El aparato MASTERFLUX plus está completo de seguridades que arreglan el control del aparato. De toda forma se aconseja de comprobar periódicamente el correcto funcionamiento del aparato haciendo los controles ordinarios.

8.2.1 Control del funcionamiento; comprobar el correcto funcionamiento siguiendo las instrucciones del par. 7.1 “Instrucción para el uso”

8.2.2 Control de las balas flotadoras que están al interior de los caudalímetros. Tiene que poder girarse sobre ellos mismos y moverse en el cono de medida al arreglar el flujo. Comprobar también que los valores ajustado queden fijos.

8.2.3 Control del pulsante FLUSH: empujar y comprobar que la bala flotadora del N2O baje hasta 0 (cero), el oxígeno tiene que estar al nivel máximo de suministro. Dejar el botón O2 FLUSH y comprobar que el suministro de O2 se interrumpa.

8.2.4 Control del pararse del flujo del N2O: elegir el suministro con concentration al 50%, cerrar la botella (así que parezca que se ha acabado) y comprobar que luego de algunos segundos el flujo del N2O se pare.

8.2.5 Controle si hay pérdidas: Cierre el mando “FLOW” (A – figura 9). Abra las válvulas de las bombonas de Oxígeno y de Protóxido y controle qué valores indican los manómetros. Cierre las válvulas de las bombonas. Deje que pasen ~ 5 minutos y controle los nuevos valores indicados en los manómetros. Si los valores coinciden, el dispositivo no tiene pérdidas.



Use solo repuestos y accesorios originales



REDUCTORES DE PRESIÓN

SIGA LAS INDICACIONES QUE SE INCLUYEN EN LOS MANUALES DE LOS DISPOSITIVOS.



MÁSCARAS Y CIRCUITO COMPLETO

SIGA LAS INDICACIONES DEL MANUAL DE LOS CIRCUITOS Y MÁSCARAS DE LOS DISPOSITIVOS.

SITUACIONES QUE PUEDEN PRODUCIRSE DURANTE EL FUNCIONAMIENTO:

Problemas	Causas posibles	Solución
No distribuye oxígeno	Bombona descargada	Cargue la bombona
	Reductor de presión que no funciona	Cambie el reductor
	Problemas internos de la caja fluxométrica	Control del dispositivo en la sede de Tecno-gaz
No distribuye protóxido de nitrógeno	Falta oxígeno	Cargue la bombona
	Reductor de presión que no funciona	Cambie el reductor
Indicador de protóxido de nitrógeno proyectado hacia la parte superior	Maniobra equivocada	Ponga a cero el mando 'FLOW' Restablezca el funcionamiento correcto
	Problema interno	Control de dispositivo en la sede de Tecno-gaz

10 PROCEDIMIENTOS PARA EL SERVICIO Y LA ASISTENCIA

La asistencia técnica debe solicitarla al depósito que ha facturado el dispositivo.

o directamente a:

TECNO-GAZ S.p.A.

Strada Cavalli 4, 43038, Sala Baganza, Parma, ITALIA.

www.tecnogaz.com

TELÉFONO	+39 0521 83.80
FAX	+39 0521 83.33.91
@	cme2@tecnogaz.com

El servicio de asistencia se encargará de evaluar si es más conveniente el envío al fabricante o bien una intervención de un técnico y, tras examinar la máquina, redacta un presupuesto de gastos que envía al cliente/distribuidor, quien, a su vez, lo transmite al cliente final para su consideración y suscripción.

Tras recibir el presupuesto firmado, el dispositivo se incluye en la programación y se envía en los plazos indicados en el módulo del presupuesto.

El dispositivo debe enviarse de la forma siguiente:

- Utilice el embalaje original; si no dispone del mismo, utilice un embalaje adecuado. La mercancía viaja por cuenta y riesgo del expedidor.
- Envíe solo la caja fluxométrica y los reductores de presión, envueltos uno por uno en un plástico limpio
Los reductores no deben contaminarse (detergentes, alcohol, aceites...); si la asistencia no considera idóneo el embalaje, los reductores deberán ser desguazados.
- Introduzca en el embalaje un documento donde se indique con precisión la anomalía detectada o el servicio solicitado.
- Envíe el dispositivo siempre con portes pagados; de lo contrario le cargaremos los gastos de transporte soportados.

Todos los embalajes no originales serán eliminados.

La máquina se devolverá con un embalaje original (el coste del embalaje se cargará) mediante el mensajero del cliente.

ÍNDICE

- 1. UTILIZAÇÃO PREVISTA E DESTINO DE USO**
- 2. SEGURANÇA**
 - 2.1 MARCAÇÃO DE SEGURANÇA
 - 2.2 DISPOSITIVOS DE SEGURANÇA
 - 2.3 MANIPULAÇÃO
 - 2.4 ELIMINAÇÃO
- 3. DADOS TÉCNICOS**
- 4. DESEMBALAGEM**
- 5. COMPONENTES**
 - 5.1 LISTA DE COMPONENTES FORNECIDOS
 - 5.2 COMPONENTES VERSÃO MÓVEL
 - 5.3 COMPONENTES VERSÃO PAREDE
 - 5.4 INTERFACE DO USUÁRIO
 - 5.5 MÁSCARAS
 - 5.6 MEDIDAS DE MÁSCARAS
 - 5.7 CIRCUITO DA MÁSCARA
- 6. INSTALAÇÃO**
 - 6.1 INSTALAÇÃO DO MASTER FLUX PLUS COM MÓVEL
 - 6.2 INSTALAÇÃO DO MASTER FLUX PLUS NA PAREDE
 - 6.3 CONEXÃO AOS CIRCUITOS E ACESSÓRIOS
 - 6.4 EVACUAÇÃO DOS GASES EXALADOS
 - 6.4.1 LIGAÇÃO DIRETA AO AMBIENTE EXTERNO DO CONSULTÓRIO
 - 6.4.2 CONEXÃO AO ASPIRADOR CIRÚRGICO
- 7. FUNCIONAMENTO DO DISPOSITIVO**
 - 7.1 PAINEL DE COMANDOS
 - 7.2 INSTRUÇÕES DE USO
 - 7.3 REANIMAÇÃO COM MASTER FLUX PLUS
- 8. MANUTENÇÃO**
 - 8.1 SUBSTITUIÇÃO DAS GARRAFAS
 - 8.2 LIMPEZA
 - 8.3 MANUTENÇÃO PROGRAMADA
- 9. SINALIZAÇÕES**
- 10. PROCEDIMENTOS PARA O SERVIÇO E ASSISTÊNCIA TÉCNICA**

DESTINO DE USO

O MASTER FLUX PLUS é um dispositivo para a administração de uma mistura de O₂ e N₂O ao paciente utilizado em técnicas de sedação consciente/analgésica sedativa.

UTILIZAÇÃO

Na mistura administrada, os valores de concentração são:

O₂ ≥ 30%

N₂O ≤ 70%

A administração é efetuada com uma máscara nasal e o paciente deve inspirar ativamente a mistura pelo nariz.

A sedação consciente é indicada para todos os pacientes do consultório odontológico, sejam eles crianças ou adultos.

A sedação consciente permite limitar o medo e a ansiedade dos pacientes que devem submeter-se a tratamentos odontológicos.

**A SEDAÇÃO CONSCIENTE NÃO É INDICADA:**

- DURANTE A GRAVIDEZ

- EM PACIENTES TOXICODEPENDENTES

- EM PRESENÇA DE GRAVES INFEÇÕES PULMONARES

- EM SUJEITOS COM GRAVES DOENÇAS MENTAIS



O MASTER FLUX PLUS deve ser utilizado apenas por pessoal médico que tenha recebido uma específica preparação.



Não utilizar este dispositivo para administrar anestesia geral ou como parte ou em associação a um sistema geral de anestesia.



A lei limita a venda deste dispositivo apenas a médicos e odontologistas.

ATENÇÃO



Não tentar reparar, modificar ou calibrar este dispositivo.

A reparação não autorizada, modificação ou abuso no uso deste dispositivo afeta negativamente o seu desempenho e anula a garantia.



Antes de cada uso, verificar se a ligação aos gases de alimentação está efetuada corretamente.



O dispositivo administra fármacos apenas para a técnica da sedação consciente.



As contraindicações sobre o uso do fármaco estão indicadas na ficha de segurança e na documentação anexada a este medicamento. Caso as contraindicações não tenham sido entregues, peça-as ao fornecedor de gás.



Não remover a placa do produto que indica o número de série e o lote de produção.



Não substituir os redutores fornecidos com outros não fornecidos pelo fabricante

2

SEGURANÇA

O uso do **OXÍMETRO DE PULSO** deve ser habitual durante a sedação consciente.

Significado da leitura dos valores detetados:



Níveis de saturação de O ₂	Grau de hipoxia
≥ 95%	Nenhuma hipoxia
90-94%	Hipoxia leve
85-89%	Hipoxia moderada
84%	Hipoxia grave

2.1 Marcação de segurança

O dispositivo está em conformidade com a diretiva 93/42 CEE e sucessivas modificações e integrações.

A declaração de conformidade está anexa ao dispositivo.

2.2 Dispositivos de segurança

O dispositivo é fornecido com dispositivos de segurança:

- Ao reduzir a pressão do oxigénio (O₂), a distribuição de protóxido de azoto (N₂O) interrompe-se automaticamente.
- Um sistema de mistura incorporado regula o N₂O de modo que na mistura de gás haja sempre uma quantidade mínima de O₂, a 30%, pelo menos.
- Se o fluxo da mistura de gás for interrompido, o paciente aspira ar do ambiente através de uma válvula de segurança.
- Se o fluxo trocar de direção, retornando ao dispositivo, uma válvula unidirecional protege o paciente que não respirará os gases exalados e as acumulações de dióxido de carbono (CO₂).
- O manípulo de definição de fluxo controla o fluxo total e regula automaticamente os fluxos de oxigénio e protóxido de azoto na percentagem configurada.
- O botão O₂ FLUSH, quando instalado, pode ser utilizado para a distribuição rápida de O₂ diretamente na saída da unidade de dosagem, permitindo distribuir altos fluxos de oxigénio puro.

**ADVERTÊNCIAS E INFORMAÇÕES ÚTEIS**

DURANTE A SUBMISSÃO DE GÁS É INDISPENSÁVEL ESTAR SEMPRE PRESENTE, MANTER SOB CONTROLO OS FLUXOS DE GÁS DE OXIGÉNIO E PROTOXÍDO DE AZOTO, ALÉM DE CONTROLAR OS VALORES DE FLUXO INDICADOS EM FLUXÍMETROS E O SACO DE CONTROLO.

2.3 Manipulação



Para deslocar o móvel Master Flux Plus usar apenas as alças fornecidas.



Figura 1

	Não empurrar o móvel sem usar as específicas alças.
	Não sentar ou apoiar pesos sobre o móvel.
	Antes de deslocar o móvel reposicionar com cuidado a máscaras e os tubos nos específicos sistemas de fixação, evitando tropeços ou rupturas.

2.4 Eliminação

A eliminação da embalagem, do dispositivo e dos componentes individuais deve ser feita no respeito das normas vigentes no país de utilização, para o tratamento e a eliminação de resíduos potencialmente biocontaminantes.

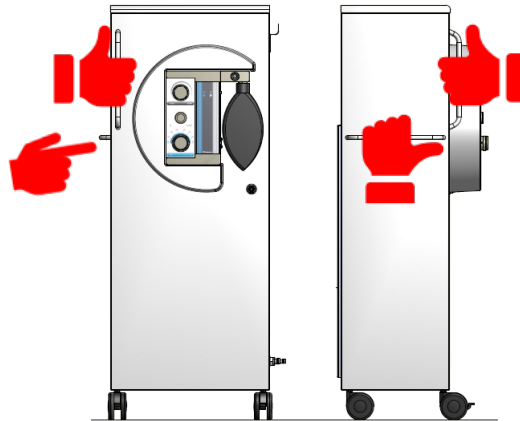
Não dispersar o material da embalagem no ambiente.

O dispositivo não contém partes elétricas/eletrónicas ou bateria.

3

DADOS TÉCNICOS

ALIMENTAÇÃO

Pressão da alimentação	3.5 bar \cong 50 PSI (máx. 6 bar \cong 87 PSI)
Capacidade máxima	10 NI/min. (litros por minuto)

PESO MASTER FLUX PLUS DE MÓVEL:

Peso sem garrafa	42 kg
Peso máximo sustentável pelo compartimento das botijas do plano rodas	180 kg
Peso máximo sustentável pelo compartimento das botijas superior	45 kg

GARRAFAS PARA MASTER FLUX PLUS COM MÓVEL:

Altura máxima	950 mm
Diâmetro máximo	140 mm

PESO DE MASTER FLUX PLUS DE PAREDE:

Peso da caixa fluxométrica	6.3 kg
----------------------------	--------

FLUXÓMETRO

Repetibilidade	+/-10% do caudal indicado
----------------	---------------------------

Leitura correta: alinhado com a parte superior plana.

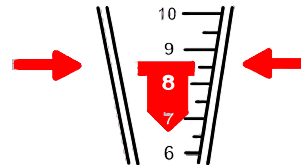

CONSUMOS:

Segue abaixo um exemplo de consumo a considerar como referência teórica:

GARRAFA DE OXIGÉNIO PARA USO MÉDICO COM CAPACIDADE PARA 10 l
CARREGADA COM PRESSÃO DE 200 bar

VOLUME DISPONÍVEL	2000 litros de gás
-------------------	--------------------

GARRAFA DE PROTÓXIDO DE AZOTO COM CAPACIDADE PARA 10 l
CARREGADA COM 7 kg DE GÁS LÍQUIDO

VOLUME DISPONÍVEL	4600 litros de gás
-------------------	--------------------

CONFIGURANDO:

DISTRIBUIÇÃO	10 NI/min.
MISTURA	50 %

AUTONOMIA:

OXIGÉNIO	400 min
PROTÓXIDO DE AZOTO	950 min



Em base às médias de consumo do gás TECNO-GAZ é aconselhável substituir a botija de Protóxido de Azoto a cada 2 botijas de Oxigénio.



Figura A



Figura B

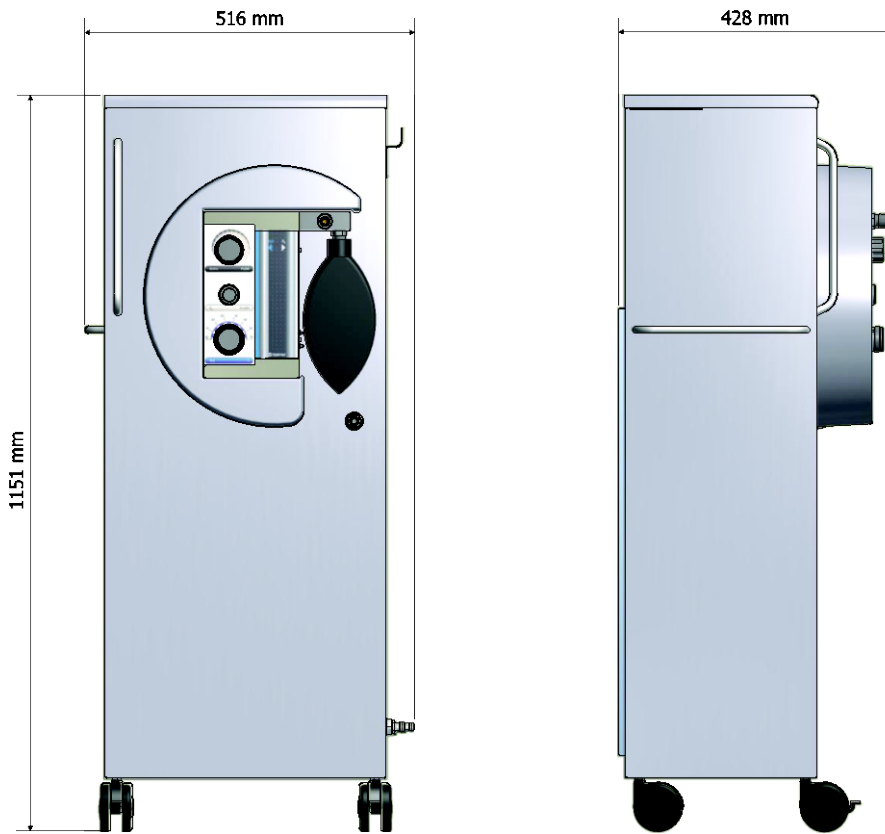

NÃO É PERMITIDO SOBREPOR OS MÓVEIS MASTER FLUX PLUS EMBALADOS

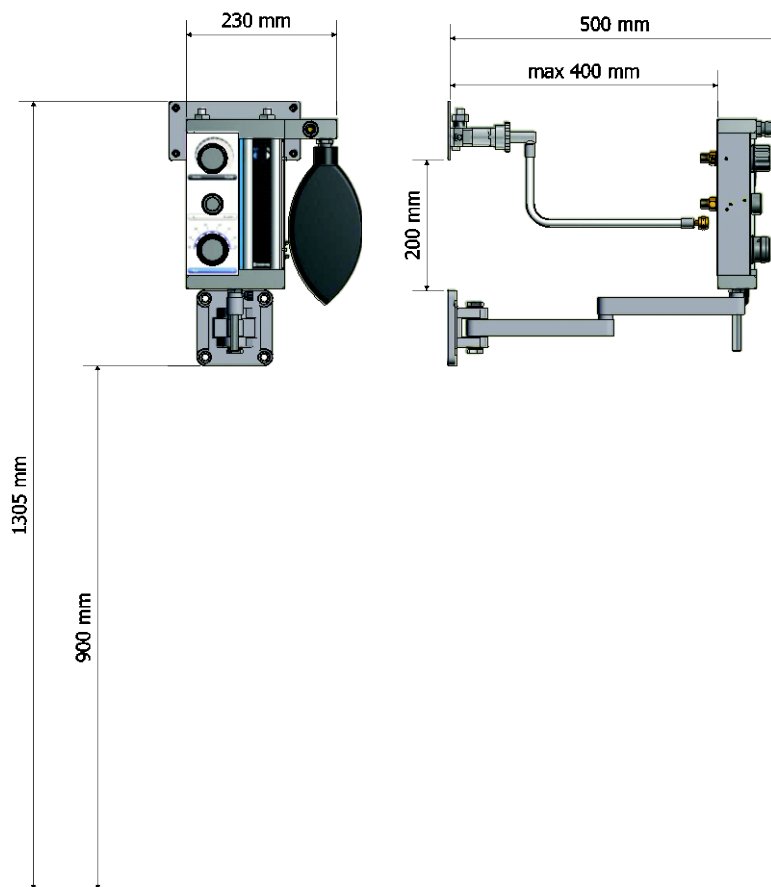

A embalagem deve ser manuseada com cuidado a fim de evitar impactos, rolamentos ou quedas.



Não utilizar aparelhos que apresentam danos evidentes causados pelo transporte.



Remover a embalagem e controlar o estado do aparelho.



A embalagem deve ser conservada durante todo o período da garantia.
O fabricante não aceita devoluções sem a embalagem original.



Os dispositivos embalados devem ser mantidos em locais secos e com limiar de temperatura de +5 a +40°C.

05

COMPONENTES

5.1

Lista de componentes fornecidos

ARTIGO	MF010ZMF Master Flux Plus de parede com redutores com oxigênio AFNOR e óxido nitroso UNI	SMFA301	SMFA301	SMFA301 Master Flux Plus de Parede com Redutores com Oxigênio e Óxido Nitroso UNI	MF009ZMF Master Flux Plus a móvel sem kit de caixa de velocidades	MF006ZMF Master Flux Plus a móvel com Redutores com Oxigênio AFNOR e Óxido Nitroso UNI	1600ASD Master Flux Plus móvel com Caixas de Velocidades com Oxigênio e Óxido Nitroso DIN	1600ASF Master Flux Plus móvel com Caixas de Velocidades com Oxigênio e Óxido Nitroso AFNOR	1600AS Master Flux Plus móvel com Caixas de Velocidades com Oxigênio e Óxido Nitroso UNI
MÓVEL	SMFA301	SMFA301	SMFA301	SMFA301	2ZMFA0020	2ZMFA0020	2ZMFA0020	2ZMFA0020	2ZMFA0020
KIT MASTER	2ZZMFA0065	2ZZMFA0063	2ZZMFA0062	2ZZMFA0062	2ZMFA0057	2ZMFA0059	2ZZMFA0058	2ZZMFA0061	2ZZMFA0060
REDUTOR N₂O	SMFA360	SMFA360	SMFA360	SMFA360		MF011ZMF	MF011ZMF	MK005ZMF	MF011ZMF
REDUTOR O₂	SMFA361	SMFA358	MF003ZMF	MF003ZMF		1513A4F	1513A4D	1513A4F	1513A4
MÁSCARAS	<p>MF820ZMF Master Flux circuit</p> <p>MF824ZMF Circuito de sucção Master Flux Plus (novo)</p> <p>MF835ZMF Intelliflux 1 máscara completa Master Flux mais 0-4 anos</p> <p>MF836ZMF Intelliflux 2 máscara completa Master Flux mais 4-10 anos</p> <p>MF837ZMF Intelliflux 3 máscara completa Master Flux plus> 10 anos</p>								

5.2

COMPONENTES versão móvel



Figura 2

FIGURA	POSIÇÃO	QUANT.	CÓDIGO	DESCRIÇÃO
3	1	1	SMFA144	COBERTURA EM PLÁSTICO
	2	1	SMFA506	CAIXA FLUXOMÉTRICA
	3	3	SMFA223	SEPARADOR
	4	3	CM25021	PARAFUSO COM ALETA M5
	5	3	3MECQ0010	SEPARADOR
	6	3	CM20015	ANILHA
	7	3	CM25019	PORCA DE ORELHAS M6
	9	2	SMFA237	PORTA-BORRACHA ELIMINAÇÃO DE GÁS

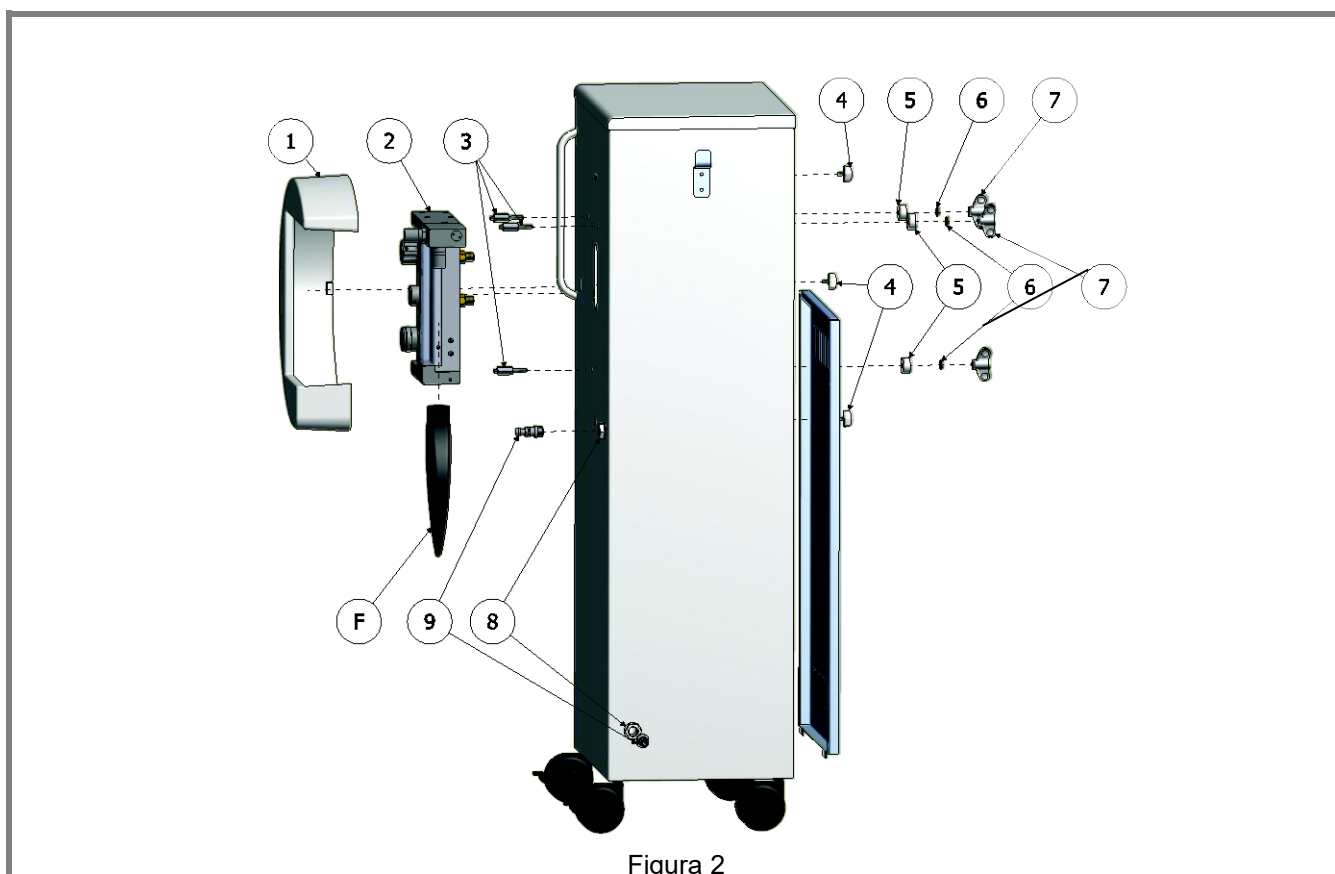

Figura 3-4

PAREDE (Figura 3-4)

FIGURA	POSIÇÃO	QUANT.	CÓDIGO	DESCRIÇÃO
4	10	1	SMFA313	PINO
	11	1	SMFA364	TUBO O ₂
	12	1	SMFA365	TUBO N ₂ O
	13	1	SMFA301	SUPORTE PARA PAREDE
	14	1	SMFA501	CHAPA DE PAREDE
	15	1	CM30011	MAÍPULO DE FIXAÇÃO DO PINO

5.4

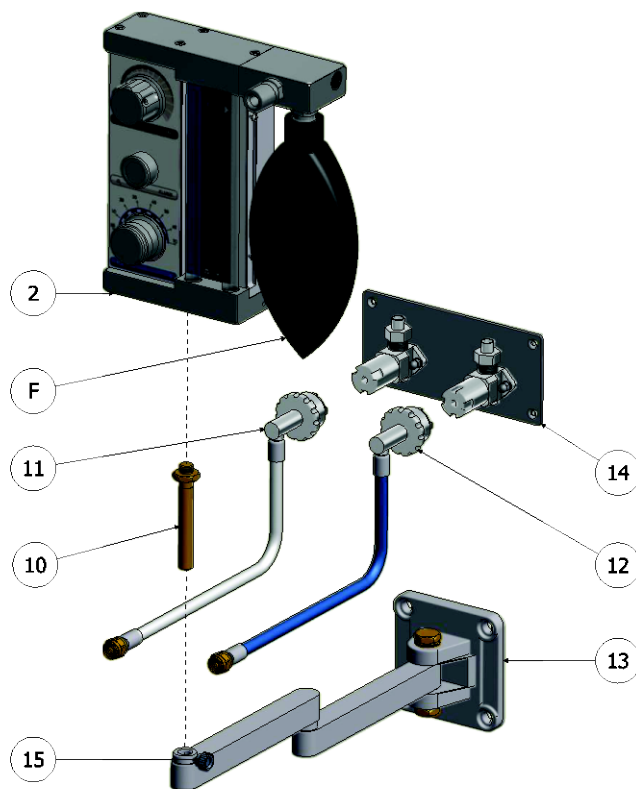
INTERFACE DO USUÁRIO



Figura 5

A	Manípulo FLOW
B	Botão FLUSH
C	Manípulo % N ₂ O
D	Fluxímetro N ₂ O
E	Fluxímetro O ₂
F	Balão reservoir
G	Porta-tubos para ligação máscara

5.5

MÁSCARAS

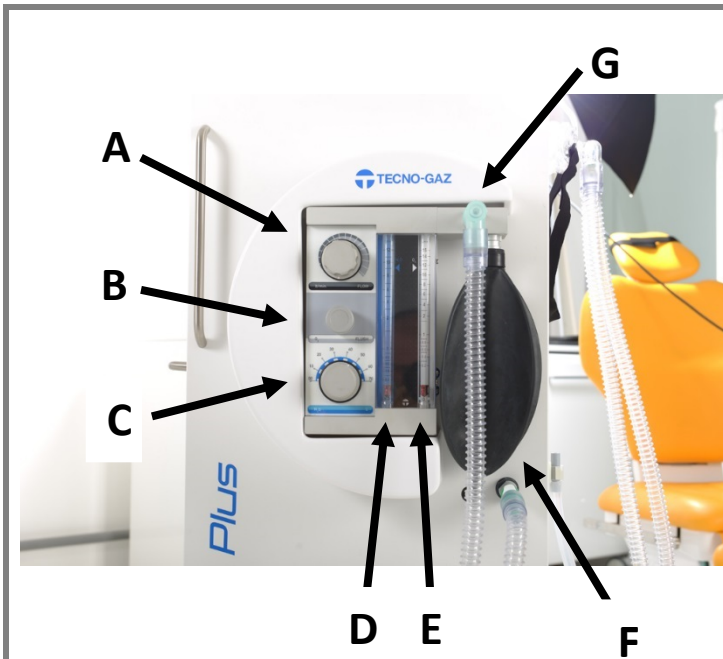

Figura 6

①	Área de suporte para a testa do paciente
②	Entrada de gás com válvula de retenção
③	Saída de gás com válvula de retenção + seta impressa no PC para indicar a direção do fluxo
④	Faixa elástica em velcro com ganchos de plástico

5.6

MEDIDAS DE MÁSCARA

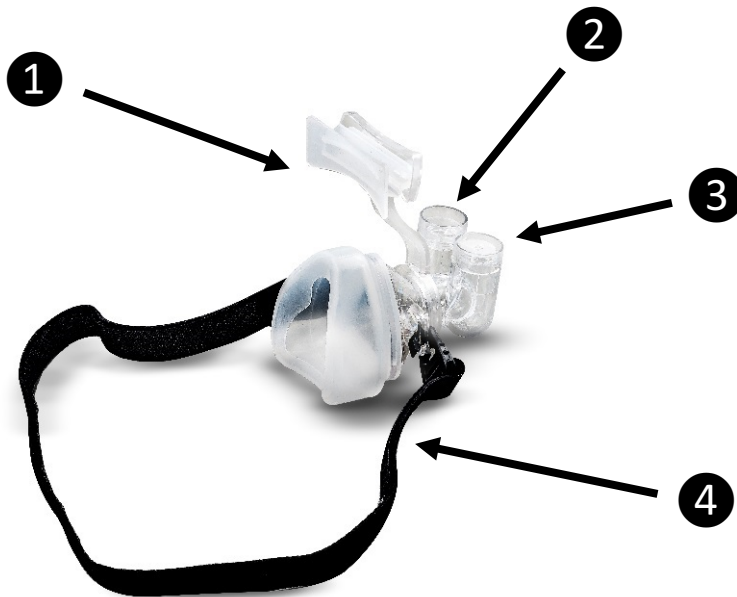
MF835ZMF	MF836ZMF	MF837ZMF	MF838ZMF
MÁSCARA 1	MÁSCARA 2	MÁSCARA 3	MÁSCARA 4
0-4 anos	4-10 anos	>10 anos	

Figura 7

5.7

CIRCUITO DA MÁSCARA



Figura 8

CIRCUITO COMPLETO DE MÁSCARAS



Figura 9



Para partes de componentes individuais, consulte o manual do usuário para "Circuitos e máscaras".

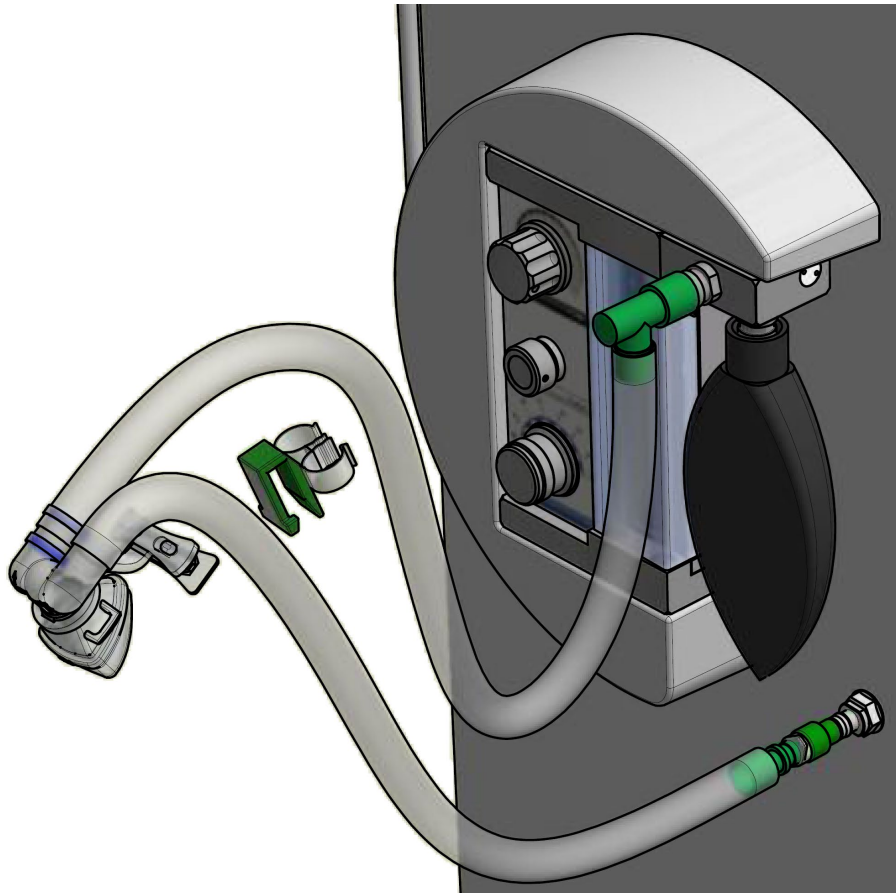

Remover a embalagem e controlar o estado do aparelho.
Não utilizar aparelhos que apresentam danos evidentes devidos ao transporte.

6.1 Instalação do MASTER FLUX PLUS com móvel

MONTAGEM DA CAIXA FLUXOMÉTRICA (Figura 2)

veja Guia Rápido 0ZMFI0007

Aparafusar os 3 separadores em aço (3) na caixa fluxométrica (2).

Remover as proteções dos bicos de alimentação da caixa fluxométrica.

Montar a caixa fluxométrica no móvel inserindo os separadores em aço (3) nos respetivos furos do móvel, fixando-os ao móvel através dos 3 separadores em plástico (5), 3 anilhas (6) e as três porcas de orelhas (7) fornecidas de série.

MONTAGEM DA TAMPA FRONTAL (Figura 2, Pos. 1)

veja Guia Rápido 0ZMFI0007

Posicionar a tampa plástica nas proximidades dos três furos no móvel.

Fixar a tampa em plástico aparafusando os três parafusos de orelhas (4) fornecidos de série.

MONTAGEM DO PORTA-BORRACHA DE DESCARGA (Figura 2, Pos. 9)

veja Guia Rápido 0ZMFI0007

Ao utilizar o tubo de descarga dos gases exalados, aparafusar o porta-borracha, fornecido de série, aos encaixes plásticos.

MONTAGEM DAS GARRAFAS (NÃO FORNECIDAS) (Figura 10)

Fixar os redutores às garrafas (consultar o manual de instrução dos redutores).

Para garrafas de 5 l, inserir o elemento suspenso e fixá-lo através das respetivas travas.

Para as garrafas de 10 e 14 l posicionar o elemento suspenso no fundo do móvel.

Os manómetros dos redutores (M) devem ser posicionados de modo que estejam bem visíveis ao operador.

Bloquear as garrafas ao móvel através da respetiva pulseira de velcro especial fornecida.

Aparafusar a porca do tubo do redutor O₂ (R1) com o bico de alimentação da caixa fluxométrica (I), (ROSCAGEM DIREITA).

Aparafusar a porca terminal do tubo do redutor O₂ (R1) com o bico de alimentação da caixa fluxométrica (H), (ROSCAGEM ESQUERDA).

Fechar a porta posterior através dos dois ímanes situados na parte superior.



Figura 10

FIGURA	POSIÇÃO	QUANT.	CÓDIGO	DESCRIÇÃO
6	R1	1	1513A4	REDUTOR O ₂ (ITA)
	R2	1	MF011ZMF	REDUTOR N ₂ O (ITA)
	L	1		VÁLVULA
	M	1		MANÓMETRO

6.2 Instalação do MASTER FLUX PLUS na parede

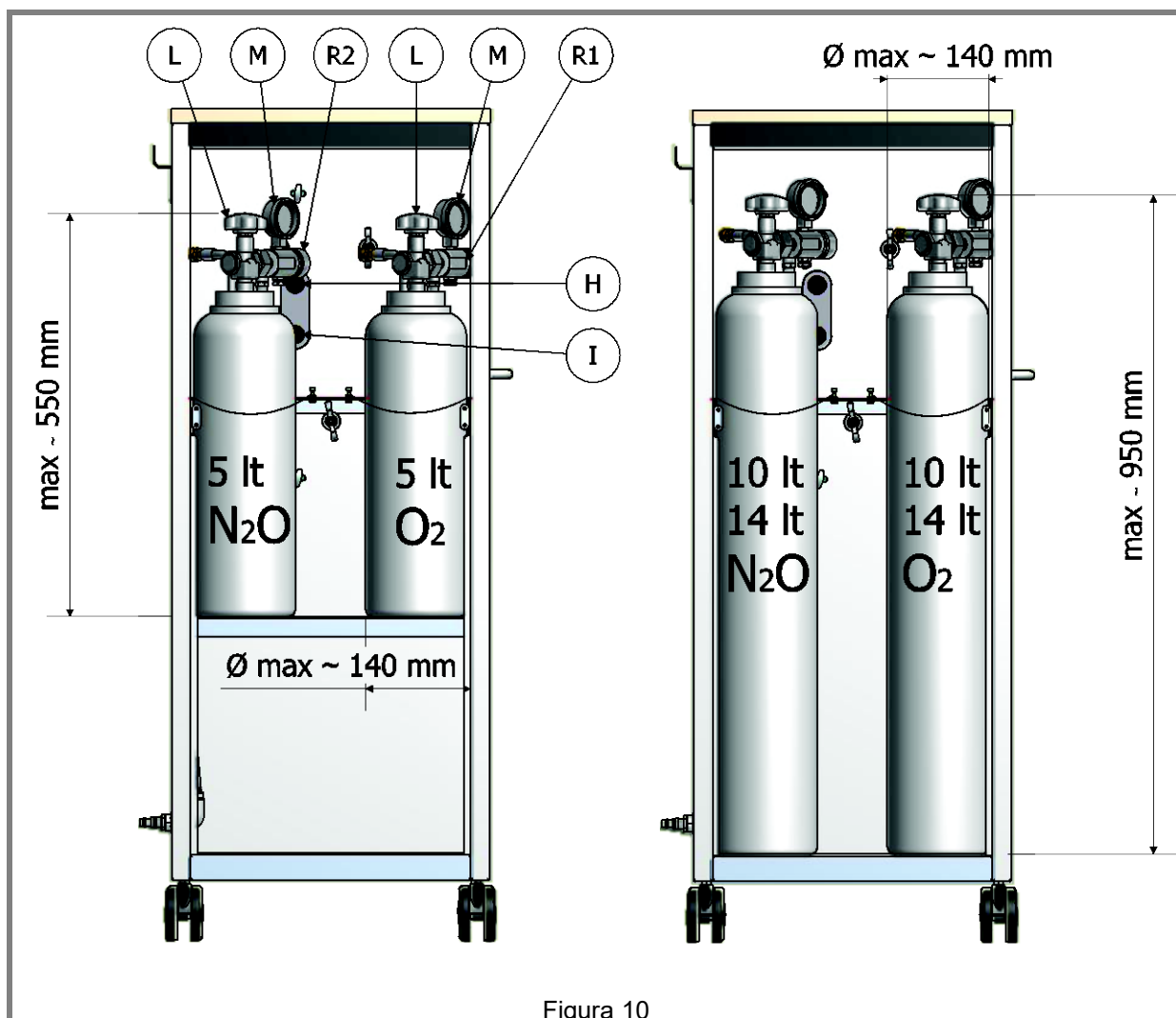

Figura 11



Figura 12

(Figura 5, 10)

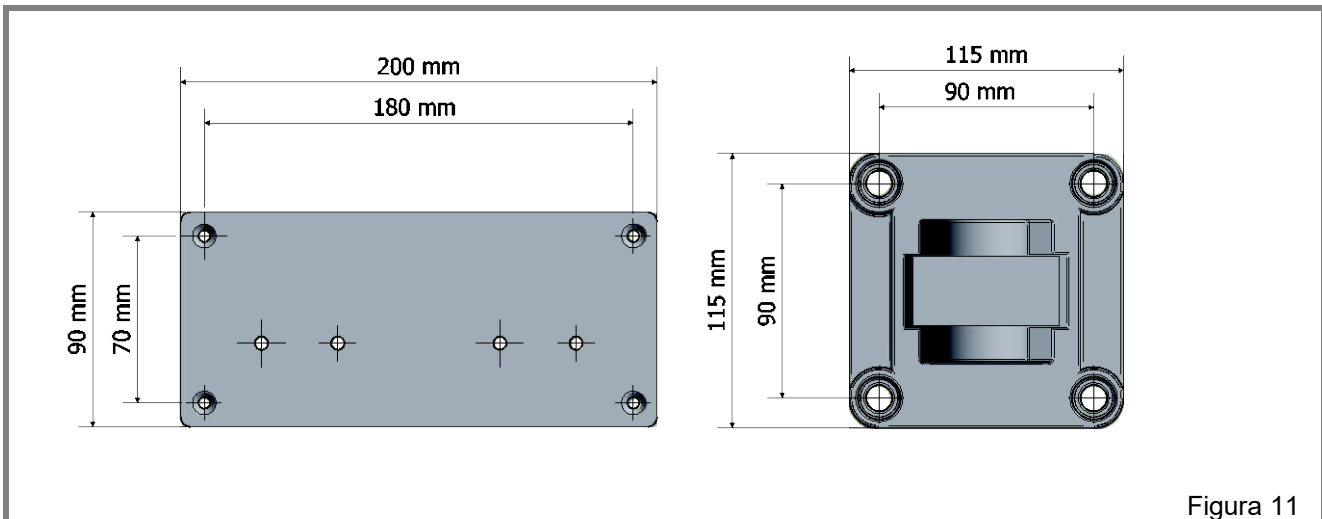
Fixar o SUPORTE MASTER FLUX PLUS na parede (13) utilizando as 4 buchas para parede com $\varnothing 14$ mm M8.

Fixar a CHAPA MASTER FLUX PLUS na parede (14) com 4 buchas para parede com $\varnothing 8$ (mm).

Aparafusar à base da caixa fluxométrica o pino (10).

Inserir o pino na parte final do suporte (15).

Bloquear o pino ao suporte com o respetivo manípulo roscado.

Aparafusar a porca do tubo O₂ com o bico de alimentação O₂ na caixa fluxométrica , (roscagem DIREITA).

Conectar a porca do tubo N₂O com o bico de alimentação N₂O situado na caixa fluxométrica , (roscagem ESQUERDA).

Conectar as extremidades livres dos tubos às entradas instaladas na parede (pressionar os engates para bloquear o encaixe à entrada).

NOTAS SOBRE O SISTEMA CENTRALIZADO

A instalação deve ser efetuada por técnicos especializados e o sistema centralizado deve ser realizado em conformidade com as diretivas em vigor.

Diretiva Europeia nº 93/42/CE

Conectar o ponto equipotencial do sistema elétrico à tomada elétrica através dos respetivos conectores com olhal fornecidos de série.

Os redutores fornecidos não devem ser conectados às garrafas do sistema centralizado.

A saída do redutor **N₂O** é composta por um tubo flexível em cuja extremidade está inserida uma junta macho com roscagem **1/4" G** para a ligação ao sistema.

A saída do redutor **N₂O** é composta por um tubo flexível em cuja extremidade está inserida uma junta macho com roscagem **1/8" G** para a ligação ao sistema.

A chapa de fixação não é fornecida.

6.3 | Conexão aos circuitos e acessórios:



Figura 13

FIGURA	POSIÇÃO	QUANT.	CÓDIGO	DESCRIÇÃO
8	A	1		MANÍPULO 'FLOW'
	B	1		BOTÃO 'FLUSH'
	C	1		MANÍPULO '% N2O'
	D	1		INDICADOR DE CAPACIDADE PARA N2O
	E	1		INDICADOR DE CAPACIDADE PARA O2
	F	1	3MEDN0002	BALÃO EM BORRACHA
	G	1		PORTA-BORRACHA DE CONEXÃO PARA A MÁSCARA
	H	1		BICO N2O
	I	1		BICO O2

Conectar o balão de borracha (F) à caixa fluxométrica inserindo-o por pressão no respetivo porta-borracha.

Conectar o tubo, entrada de gás, do circuito máscara ao porta-borracha (G).

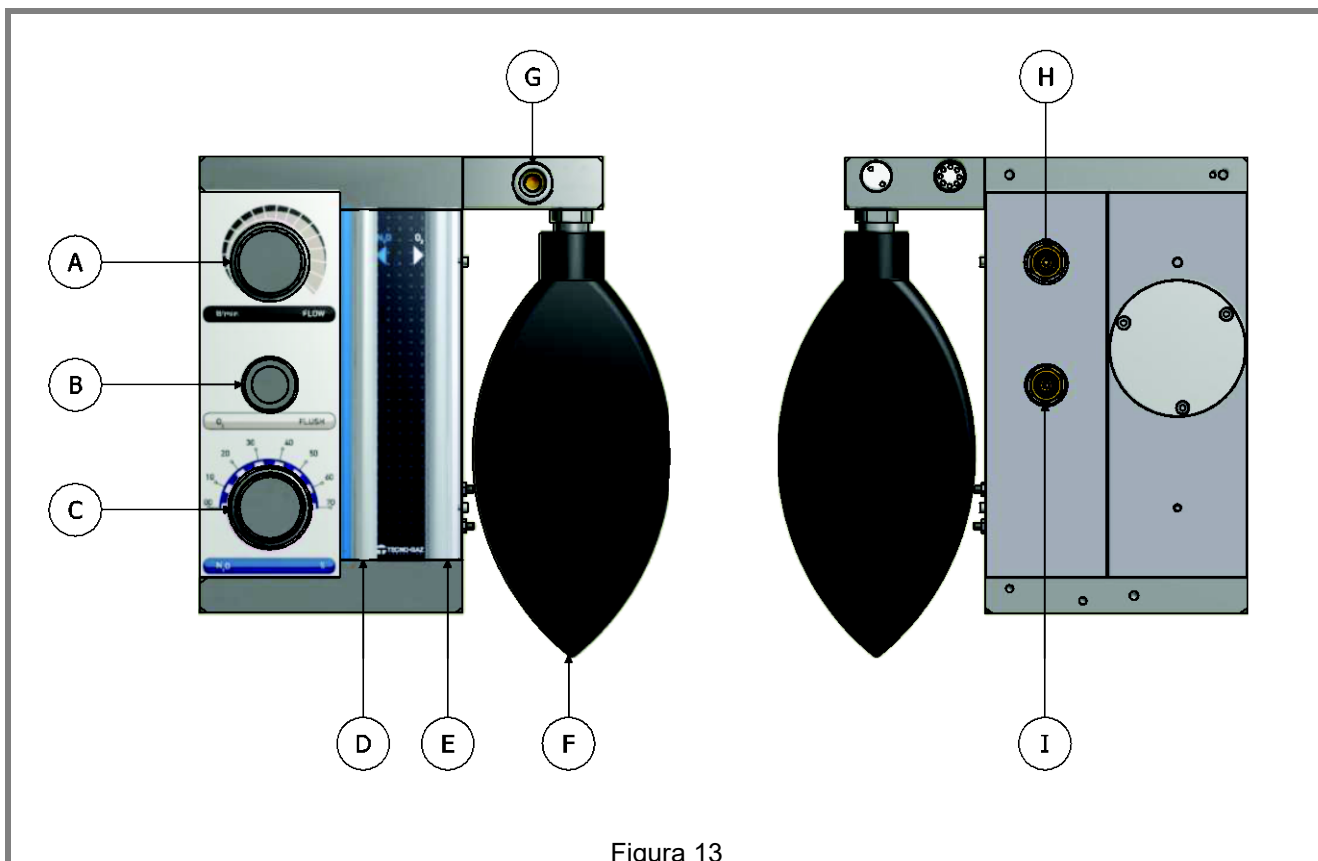
O tubo de descarga de gás será conectado com modalidade diversa, segundo o tipo de evacuação do gás utilizado. (consultar o item 6.4 - EVACUAÇÃO DOS GASES EXALADOS).

6.4 Evacuação dos gases exalados:

Para a segurança do ambiente de trabalho e dos operadores, os gases exalados devem ser direcionados para fora do ambiente de trabalho.

Podem ser utilizados dois sistemas para descarregar os gases ao ar livre:

- Ligação direta ao ambiente externo do consultório.
- Conexão ao aspirador cirúrgico.

É importante avaliar:

- A idoneidade do aspirador à evacuação de gases (N_2O e O_2).
- A descarga do aspirador deve ser feita ao ambiente externo e ventilado.

Controlar a conformidade às normativas em vigor no país de uso.

6.4.1 LIGAÇÃO DIRETA AO AMBIENTE EXTERNO DO CONSULTÓRIO

MASTER FLUX PLUS DE MÓVEL:

Aparafusar o porta-borracha (Figura 2, Pos 8/9) ao móvel.

Eliminar a válvula fornecida de série.

Conectar o tubo de descarga do gás do circuito da máscara ao porta-borracha (Figura 15).

Conectar o tubo em espiral de evacuação do gás (Figura 14) ao porta-borracha do móvel.

Colocar a extremidade do tubo em espiral no lado externo e controlar se o filtro final está instalado (Figura 14, Pos 34).

MASTER FLUX PLUS DE PAREDE:

Conectar o tubo de descarga do gás do circuito da máscara ao porta-borracha (Figura 14, Pos 36).

Colocar a extremidade do tubo em espiral no lado externo e controlar se o filtro final está instalado (Figura 14, Pos. 34).



FIGURA	POSIÇÃO	QUANT.	CÓDIGO	DESCRIÇÃO
9	34	1	SMFA197	FILTRO - SMFA260
	35	1		TUBO – SMFA199
	36	1		ENCAIXE – SMFA257



Figura 15

6.4.2 CONEXÃO AO ASPIRADOR CIRÚRGICO**MASTER FLUX PLUS DE MÓVEL:**

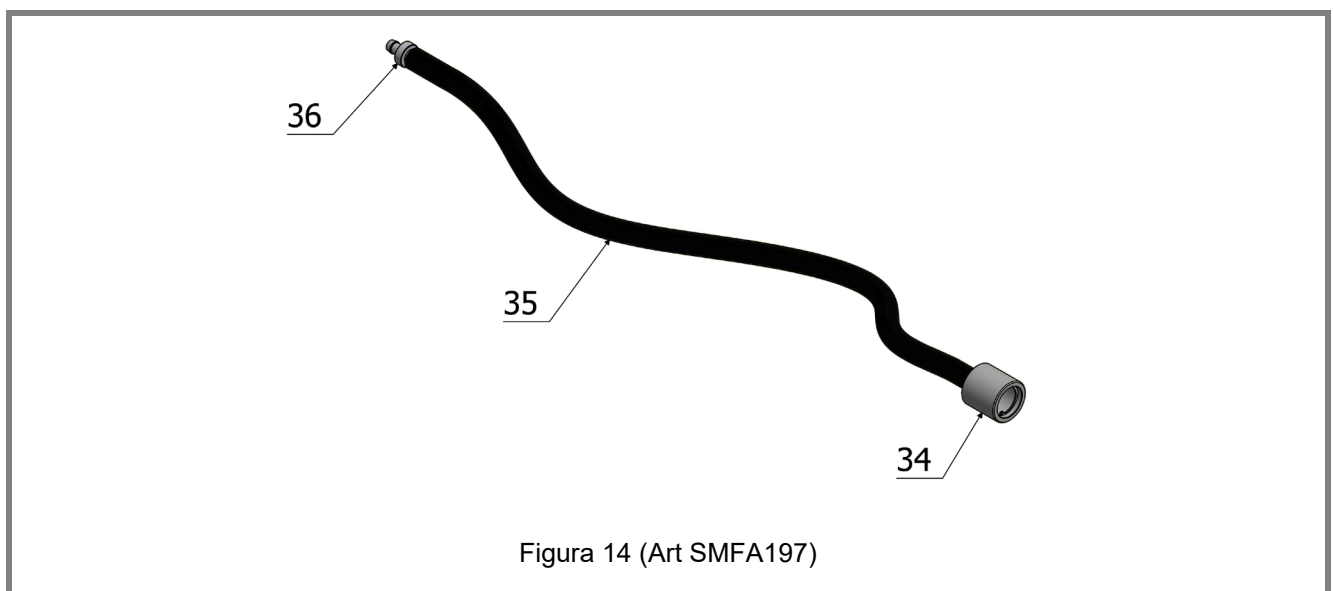
Rosqueie as mangueiras (Figura 2 Pos 8/9) na peça de móvel.

Conectar o tubo de descarga do gás do circuito da máscara à válvula (Figura 17) fornecida.

Conecte o circuito de sucção (Figura 16) ao encaixe de móvel.

Conectar a válvula ao tubo do aspirador cirúrgico (Ø11).

MASTER FLUX PLUS DE PAREDE:

Remova o tubo (Figura 16 Pos 43)

Conecte o tubo, descarga de gás do circuito de máscara, à válvula (Figura 16 Pos 44).

Conectar a válvula ao tubo do aspirador cirúrgico (Ø11).

REGULAÇÃO DA VÁLVULA

Girar a virola perfurada da válvula (Figura 5, Pos. 17) até o fechamento dos furos.

Ativar a distribuição do gás configurando ~10 l/min.

Ativar o aspirador cirúrgico e configurar o valor mínimo de aspiração.

Observar o balão (Figura 8, Pos. F).

Girar a virola perfurada da válvula abrindo progressivamente os furos até obter o estado ideal do balão em condição “MEIO CHEIO/MEIO VAZIO”.

ATENÇÃO:

Com o alterar de fluxos distribuídos, pode ser necessário regular os corretos fluxos de aspiração dos gases exalados.



Figura 16 (Art MF824ZMF)

FIGURA	POSIÇÃO	QUANT.	DESCRIÇÃO
9A	41	1	REDUÇÃO
	42	1	PARTE TERMINAL
	43	2	TUBOS
	44	1	VÁLVULA

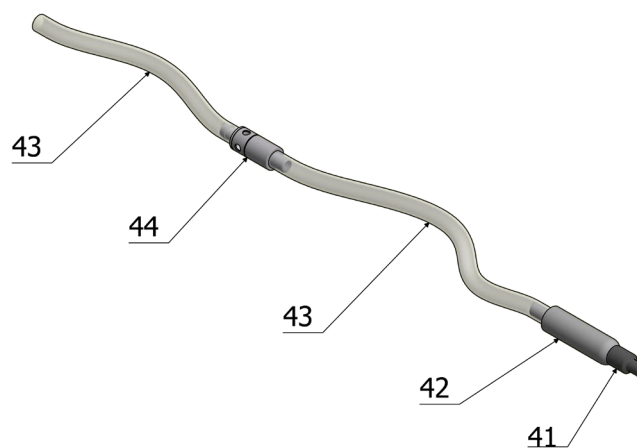

Figura 17

7

FUNCIONAMENTO DO DISPOSITIVO

7.1 Painel de comandos



Figura 18

TECLAS DE COMANDO (FIGURA A10)





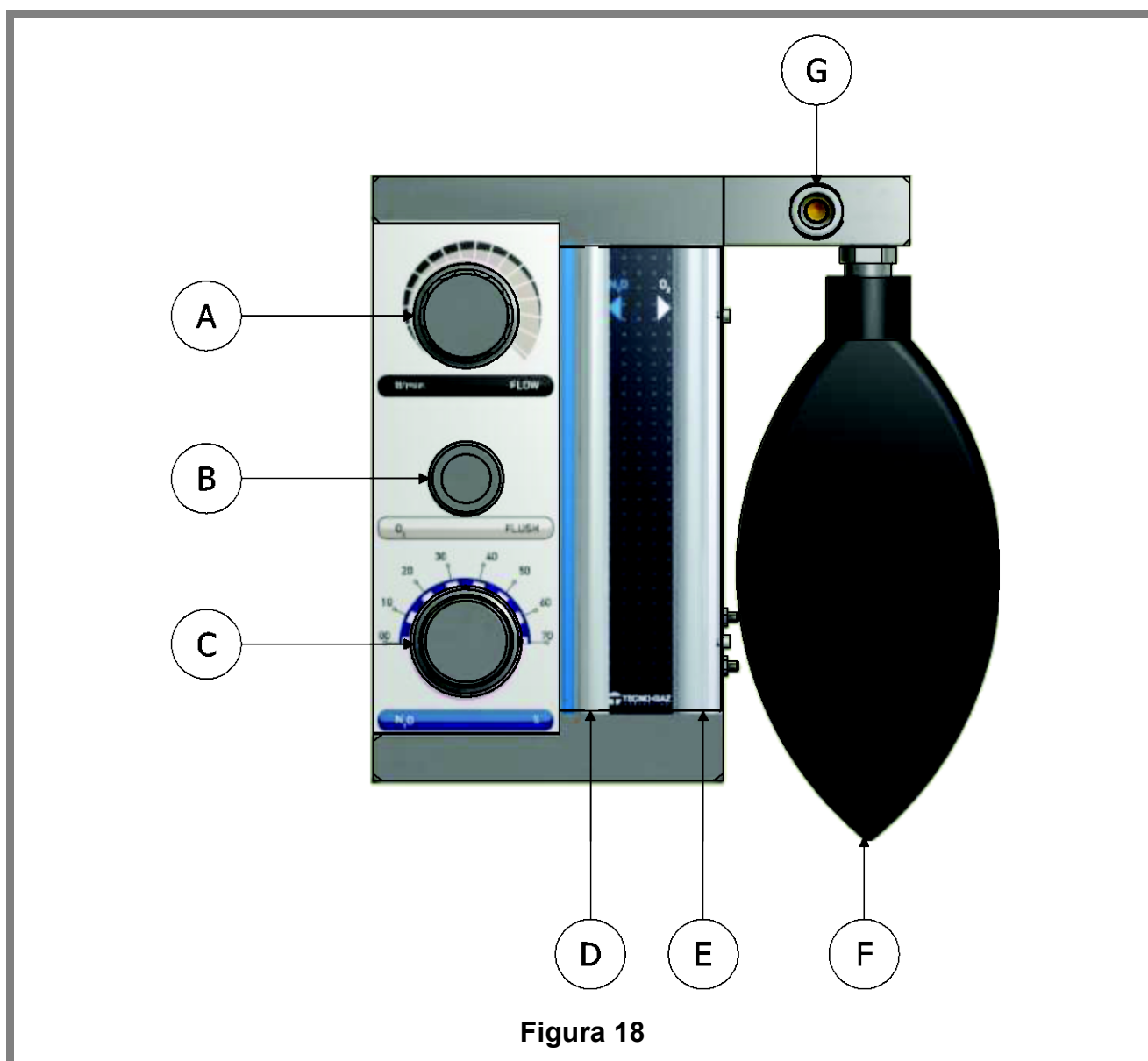

A	REGULAÇÃO DO FLUXO DISTRIBUÍDO
B	BOTÃO DE EMERGÊNCIA "FLUSH"
C	REGULAÇÃO EM % DA MISTURA DE PROTÓXIDO DE AZOTO

ELEMENTOS DE CONTROLO



E	FLUXO DE OXIGÉNIO PURO
D	FLUXO DE PROTÓXIDO DE AZOTO PURO
F	BALÃO (CONTROLO - FLUXO IDÓNEO AO PACIENTE)

Antes de iniciar a utilizar o dispositivo MASTER FLUX PLUS na versão com móvel bloquear as rodas com travão pressionando para baixo as respetivas linguetas.

Se for necessário deslocar o aparelho (por exemplo, de uma divisão para a outra) desbloquear as rodas e empurrar delicadamente o dispositivo utilizando as pegas, ver parágrafo 2.3.

	Evitar impactos e movimentos bruscos que possam causar quedas acidentais.
	Deslocar e posicionar o MASTER FLUX PLUS apenas em superfícies não inclinadas e lisas.
	Controlar a estabilidade e a correta fixação das garrafas.
	Fechar as garrafas antes de movimentar o dispositivo.
	Não utilizar os puxadores para elevar o dispositivo.
	Não mova o dispositivo usando as alças.
	Não exponha os controles a choques involuntários.

Durante o uso de MASTER FLUX PLUS na versão de parede, é possível deslocar e orientar a caixa fluxométrica onde desejar, segurando através do respetivo puxador.

	NÃO APOIAR-SE E NÃO APOIAR OBJETO ALGUM NA CAIXA FLUXOMÉTRICA (TANTO NA VERSÃO COM MÓVEL QUANTO DE PAREDE). NÃO FORÇAR O BRAÇO NA VERSÃO DE PAREDE.
	ABRIR LENTAMENTE AS VÁLVULAS DAS GARRAFAS DE O₂ E N₂O E GIRAR EM SENTIDO ANTI-HORÁRIO AS TORNEIRAS (FIGURA 10, POS. L).

Ler a pressão indicada nos manómetros dos redutores de pressão (consultar os DADOS TÉCNICOS) para estimar a autonomia da garrafa de oxigénio.

Verificar que o balão e os tubos estejam bem inseridos nas suas junções.

Escolher uma máscara idónea ao paciente.

Posicionar a máscara de modo que permaneça aderida ao contorno do nariz do paciente.

Fixar a máscara através do bloqueador de tubo com regulação atrás do apoio de cabeça da poltrona.

Controlar se os tubos do circuito da máscara apresentam dobras ou estrangulamentos.

O operador deve posicionar-se de modo que possa controlar visualmente:

- o balão em borracha;
- fluxímetros



Durante a terapia, controlar constantemente os fluxos indicados por fluxímetros (Figura 13 Pos D, E).



Antes de afastar-se do paciente, mesmo que por breves períodos, interromper a sedação.

Controlar se o índice do manípulo (Pos C) %N₂O indica o valor "0".

Administrar, utilizando o manípulo FLOW (Pos. A), uma quantidade de 3 l/min. de fluxo de oxigénio por 30 segundos.

COMUNICAR AO PACIENTE QUE DEVE INSPIRAR E EXPIRAR COM O NARIZ.

Utilizar o manípulo **FLOW** (Pos. A) para regular o fluxo.

Alterar progressivamente o fluxo, avaliar o estado do balão (Figura 18, Pos. F); o balão deve haver uma forma que definimos como **meio cheio, meio vazio**.

Deixar o paciente respirar pelo menos por um minuto antes de avaliar o fluxo.

Após determinar o fluxo ideal e determinar a capacidade pulmonar do paciente, regular a válvula de eliminação de gás como indicado no parágrafo 6.4 "Evacuação dos gases exalados".

Com o manípulo % (Figura 18, Pos. C) é possível modificar a percentagem de protóxido de azoto.

Fluxímetros mostram os litros/min. de protóxido de azoto e oxigénio distribuídos.

A soma das duas capacidades é aquela configurada inicialmente em função da capacidade respiratória do paciente.



As indicações abaixo mencionadas são exemplos de administração. Cada utilizador deve configurar o fluxo e a percentagem em base ao paciente que se submete à administração do fármaco.

ESPECIFICAÇÕES DE TERAPIA PARA CRIANÇAS:

O fluxo aproximado para CRIANÇAS é de 4-5 l/min.

- Girar em sentido horário o manípulo "FLOW" [FLUXO] configurando um fluxo de 4/5 l/min. e deixar inspirar por ~1 minuto, aproximadamente.
- Controlar o fluxo configurado na coluna O₂ (Figura 10, Pos E).
- O balão deve estar em condição de meio cheio/meio vazio.

ESPECIFICAÇÕES DE TERAPIA PARA ADULTOS:

O fluxo aproximado para ADULTOS é de 6-8 l/min.

- Girar em sentido horário o manípulo "FLOW" [FLUXO] configurando um fluxo de 6/8 l/min. e deixar inspirar por ~1 minuto, aproximadamente.
- Controlar o fluxo configurado na coluna O₂ (Figura 10, Pos E).
- O balão deve estar em condição de meio cheio/meio vazio.

Com o manípulo (Figura 18 Pos. C) % N₂O administrar o protóxido de azoto, configurar em 20%, aguardar alguns minutos e observar a reação do paciente.

Se o paciente não estiver sedado, aumentar progressivamente a percentagem (por exemplo: 30%).

A PERCENTAGEM DE PROTÓXIDO DE AZOTO ADMINISTRADA AO PACIENTE DEVE SER: A MAIS BAIXA POSSÍVEL PARA OBTER UMA BOA SEDAÇÃO (BASE LINE).

Após estabelecer a BASE LINE do paciente, sinalizar o valor de FLUXO e a percentagem de N₂O nos registos clínicos do paciente pois estes dados serão úteis para as próximas sessões.



**A MISTURA DE GÁS ADMINISTRADA AO PACIENTE:
NÃO DEVE SER SUPERIOR A 70% DE PROTÓXIDO DE AZOTO
NÃO DEVE SER INFERIOR A 30% DE OXIGÉNIO**



**Em caso de sintomas de mal-estar do paciente (náusea, vertigens, dor de cabeça), interromper imediatamente a terapia.
No dispositivo está instalado o botão “FLUSH” (Figura 13, Pos. B).
Pressionar este botão para encher o balão com oxigénio.
Pressionar o balão para administrar quantidades elevadas de oxigénio puro ao paciente.**

CONCLUSÃO DA TERAPIA

A terapia estará concluída quando o odontologista terminar a intervenção no paciente.

Para concluir a terapia:

- **Interromper a distribuição de PROTÓXIDO DE AZONO girando o manípulo (Figura 10, Pos. C) %N₂O (em sentido anti-horário) até o final (0%).**
- **Administrar (como início da terapia) um fluxo de 3 l/min. de oxigénio por 2 minutos.**
- **Interromper a distribuição de OXIGÉNIO girando o manípulo (Figura 10, Pos. A) FLOW (em sentido anti-horário) até o final.**
- **Soltando o bloqueador de tubo com regulação e retirar a máscara do paciente.**

Antes de dar alta ao paciente, mantê-lo em observação (na sala de espera) por 5 ou 10 minutos.

O médico pode aumentar o tempo de observação de considerar necessário.

FECHAMENTO DAS GARRAFAS



Após terminar o uso do dispositivo, é IMPORTANTE fechar as garrafas.



Fechar a torneira da garrafa de Protóxido (N₂O), girando em sentido horário.



Fechar a torneira da garrafa de Oxigénio (O₂), girando em sentido horário.

DEPÓSITO BOTIJAS



No final do dia, armazene os cilindros em um depósito em conformidade com as leis em vigor

7.3 REANIMAÇÃO COM MASTER FLUX PLUS

*KIT Art. 1504/A (Não fornecido de série), (Figura 19)



Os procedimentos de REANIMAÇÃO OM MASTER FLUX PLUS devem ser efetuados com o manípulo %N₂O de regulação da percentagem de protóxido de azoto posicionado em 0%.

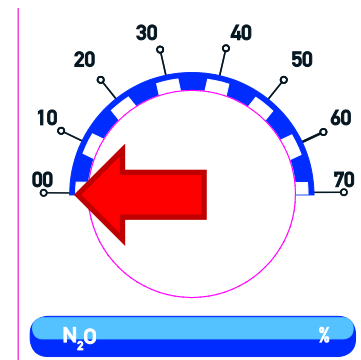

Abrir LENTAMENTE a válvula da garrafa do oxigénio (girar a torneira em sentido anti-horário), controlar se a garrafa do protóxido de azoto está fechada (girar a torneira em sentido horário).

Remover o kit de máscara do MASTER FLUX PLUS retirando-o do tubo em espiral.

Inserir no tubo em espiral a específica junta **(30)**.

Remover o saco **(F)** e inserir a respetiva tampa **(T)**.

Conectar a extremidade do tubo para a terapia de oxigénio **(31)** à junta **(30)**.

Conectar a outra extremidade do tubo para a terapia de oxigénio ao pino inferior do balão de reanimação **(32)** através do respetivo engate.

Conectar a máscara **(33)** à válvula do balão de reanimação.

Girar o manípulo **FLOW** para distribuir oxigénio ao fluxo desejado e **CONTROLAR OS FLUXOS INDICADOS**.

Fluxímetro do PROTÓXIDO DE AZOTO = 0

Fluxímetro do OXIGÉNIO = FLUXO CONFIGURADO

Posicionar a máscara no paciente.

Atuar no saco do balão de reanimação em concomitância com os procedimentos para a reanimação.

Após utilizar o dispositivo é **IMPORTANTE** fechar a torneira da garrafa do oxigénio (girando em sentido horário).



Figura 19

FIGURA	POSIÇÃO	QUANT.	CÓDIGO	DESCRIÇÃO
11	29	1	1504/A OPCIONAL	TUBO EM ESPIRAL - CM88051
	30	1		ENCAIXE – SMFA278
	31	1		TUBO PARA OXIGÉNIO – CM84022
	32	1		BALÃO DE REANIMAÇÃO – 1025-2
	33	1		MÁSCARA DE REANIMAÇÃO – CM84014

8

MANUTENÇÃO

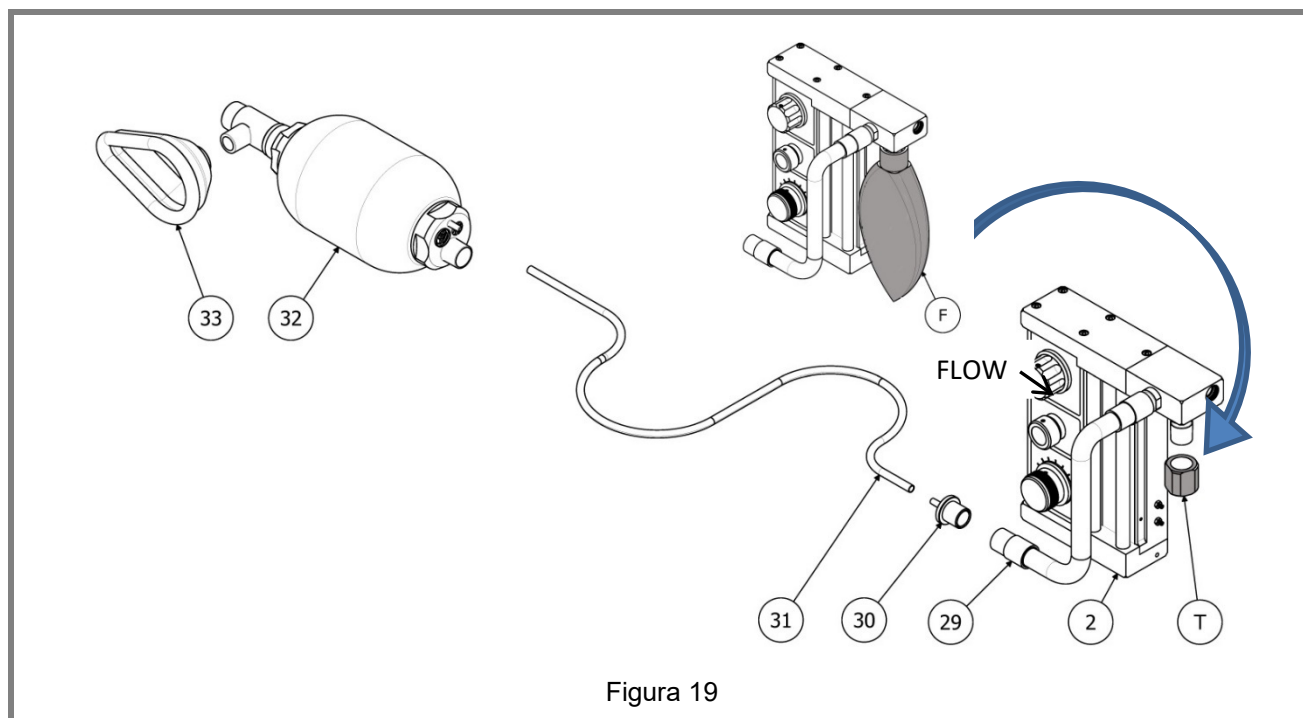
8.1

SUBSTITUIÇÃO DAS GARRAFAS

Se a pressão das garrafas for muito baixa (~10÷20 bar), substituir ou recarregar as garrafas.



Recomendamos a substituição da garrafa de óxido nítrico a cada 2 tanques de oxigênio.

Fechar lentamente as válvulas (girar em sentido anti-horário).

Descarregar o sistema abrindo-o através do manípulo "FLOW" e '%' e fechar o sistema.

Desmontar os redutores de pressão conservando-os em local protegido e limpo (consultar a instalação).

A recarga, o controlo e o teste periódico das garrafas deve ser efetuado por empresas especializadas em conformidade com as diretivas em vigor no país de uso.

8.2

Limpeza



Utilizar detergentes não agressivos para o material plástico.

Limpar as superfícies do dispositivo com pano seco.

Antes e depois do uso, é necessário limpar, desinfetar ou esterilizar os elementos em contacto com o paciente ou com sua respiração.



Limpar com Detergente com efeito antiestático Plaxiglass® de proteção dos fluxímetros

Tabela para a limpeza dos componentes MASTER FLUX PLUS

FIG/POS	MATERIAL	CÓDIGO	DESCRIÇÃO	ESTERILIZAÇÃO COM VAPOR	NÚMERO DE CICLOS DE ESTERILIZAÇÃO
3 / F	NEOPRENE	3MEDN0002	BALÃO EM BORRACHA	NO	-



Para limpar a máscara (peças de silicone e casca), consulte o manual do usuário "Circuits and Masks".



OS ARTIGOS FORNECIDOS VARIAM EM FUNÇÃO DA CONFIGURAÇÃO DO DISPOSITIVO

8.3 Manutenção programada



Antes de cada uso controlar a integridade dos componentes.



Se o MASTER FLUX PLUS permanecer parado por mais de um mês, é necessário verificar o funcionamento.

O dispositivo MASTER FLUX PLUS tem seguranças que regulamentam o correto controlo do dispositivo, porém, aconselha-se controlar periodicamente o funcionamento do dispositivo efetuando os seguintes controlos ordinários:

8.2.1 Controlo do funcionamento: Controlar o funcionamento de acordo com as instruções indicadas no parágrafo "7.1 - Instruções para o uso".

8.2.2 Controlo dos flutuantes presentes no interior das fluxímetros: devem girar sobre si próprios e mover-se livremente no cone de medida quando os caudais forem regulados. Além disso, certificar-se de que os valores regulados sejam estáveis.

8.2.3 Controlo do botão FLUSH: pressionar e controlar se o flutuante da coluna N20 diminui para 0 (zero) com o oxigénio em distribuição máxima. Libertar o botão O2 FLUSH controlando se a distribuição de o2 é interrompida.

8.2.4 Controlo do bloqueio de N2O: Configurar uma distribuição com concentração de 50%, fechar a garrafa do oxigénio (simulando uma situação de garrafa terminada) e certificar-se de que após alguns segundos a distribuição de N20 seja bloqueada completamente.

8.2.5 Verificação de perdas: Fechar o manípulo "FLOW" (A – figura 9). Abrir as válvulas das garrafas de oxigénio e protóxido e detetar os valores indicados nos manómetros. Fechar as válvulas das garrafas. Deixar passar mais ou menos 5 minutos e detetar os novos valores indicados pelos manómetros. Se os valores coincidem, o dispositivo não apresenta perdas.



Utilizar exclusivamente peças sobressalentes e acessórios originais.



**REDUTORES DE PRESSÃO
SEGUIR AS INDICAÇÕES INDICADAS NOS MANUAIS DOS DISPOSITIVOS.**



**MÁSCARAS E CIRCUITO COMPLETO
SEGUIR AS INDICAÇÕES NO MANUAL DE CIRCUITOS E MÁSCARAS DOS DISPOSITIVOS.**

SITUAÇÕES QUE PODEM OCORRER DURANTE O FUNCIONAMENTO:

Problemas	Possíveis causas	Solução
O aparelho não fornece oxigénio	Garrafa descarregada	Carregar a garrafa
	Redutor de pressão não funciona	Substituir o redutor
	Problemas no interior da caixa fluxométrica	Controlo do dispositivo realizado nos estabelecimentos de Tecno-gaz
O aparelho não fornece protóxido de azoto	Falta oxigénio	Carregar a garrafa
	Redutor de pressão não funciona	Substituir o redutor
Indicador de protóxido voltado para a parte superior	Manobra incorreta	Colocar em zero o manípulo "FLOW" (fluxo) Restabelecer o correto funcionamento.
	Problema interno.	Controlo do dispositivo realizado nos estabelecimentos de Tecno-gaz

10 PROCEDIMENTOS PARA O SERVIÇO E ASSISTÊNCIA TÉCNICA

A assistência técnica deve ser solicitada ao depósito que faturou o dispositivo ou então diretamente a:

TECNO – GAZ S.p.A.

Strada Cavalli 4, 43038, Sala Baganza, Parma, ITÁLIA.

www.tecnogaz.com

TELEFONE:	+39 0521 83.80
FAX:	+39 0521 83.33.91
@	cme2@tecnogaz.com

A assistência técnica avaliará a reentrada em sede ou a intervenção de um técnico e inspeção da máquina para estabelecer um orçamento que será sucessivamente encaminhado ao revendedor que, por sua vez, transmitirá ao cliente final para conhecimento e subscrição.

Após receber o orçamento para aceitação, o dispositivo será colocado em serviço e expedido dentro do prazo indicado no módulo de orçamento.

Seguir as indicações abaixo descritas para expedir o dispositivo:

- Caso a embalagem original não esteja mais disponível, utilizar uma semelhante. A mercadoria viaja com risco sob a responsabilidade do destinatário.
- Enviar apenas a caixa fluxométrica e os redutores de pressão inseridos individualmente em celofane limpo.
Os redutores não devem ser contaminados (detergentes, álcool, óleos, etc.); se a assistência técnica considerar a embalagem não idónea, os redutores serão desmontados.
- Indicar por escrito e inserir na embalagem um documento no qual esteja indicada a anomalia detetada com precisão ou o serviço que pretender utilizar.
- Enviar sempre com porte pago, caso contrário, as despesas de transporte serão debitadas.

Todas as embalagens que a fábrica receber serão eliminadas.

A máquina será enviada com embalagem original (o custo da embalagem será debitado) mediante expedidor.



TECNO-GAZ S.p.A.

*Strada Cavalli N°4 • 43038
Sala Baganza • Parma • ITALIA
Tel. +39 0521 83.80
Fax. +39 0521 83.33.91*

www.tecnogaz.com

I
E
N
F
D
E
P

Il presente manuale deve sempre accompagnare il prodotto, in adempimento alle Direttive Comunitarie Europee. TECNO-GAZ, si riserva il diritto di apporre modifiche al presente documento senza dare alcun pre-avviso. La ditta TECNO-GAZ si riserva la proprietà del presente documento e ne vieta l'utilizzo o la divulgazione a terzi senza il proprio benestare.

This manual must always be kept with the product, in complying with the Directives of European Community. TECNO-GAZ reserves the right to modify the enclosed document without notice. TECNO-GAZ reserves the property of the document and forbids others to use it or spread it without its approval.

Ce manuel doit toujours accompagner l'appareil conformément aux Directives de la Communauté européenne. TECNO-GAZ se réserve le droit d'y apporter des modifications sans aucun préavis. TECNO-GAZ se réserve la propriété de ce manuel. Toute utilisation ou divulgation à des tiers est interdite sans son autorisation.

Diese Anleitung muss dem Gerät in Übereinstimmung mit den Richtlinien der Europäischen Gemeinschaft beigelegt werden. TECNO-GAZ behält sich dar Recht vor ohne Vorankündigung Änderungen in dieser Dokumentation vorzunehmen. Die Firma TECNO-GAZ ist Eigentümer der vorliegenden Dokumentation und verbietet die Nutzung von Dritten oder die Weitergabe an Dritte ohne entsprechende Genehmigung.

El presente manual siempre deberá acompañar el producto al cual pertenece, cumpliendo las Directivas Comunitarias Europeas. TECNO-GAZ, reserva el derecho de aportar alteraciones al presente documento sin avisos previos. La empresa TECNO-GAZ reserva a si los derechos de propiedad del presente documento prohibiendo su utilización o divulgación a terceros sin que haya expresado su consentimiento.

Este manual deve sempre acompanhar o produto, em conformidade com as directivas da UE. TECNO-GAZ, reserva-se o direito de fazer alterações neste documento sem dar qualquer aviso prévio. TECNO-GAZ reserva a propriedade deste documento e proíbe o uso ou divulgação a terceiros sem a sua aprovação.